

Robert Bosch Power Tools GmbH
70538 Stuttgart
GERMANY

www.bosch-pt.com

1 609 92A 2VJ (2013.11) AS / 15 XXX



1 609 92A 2VJ

GWS Professional

8-115 | 8-125 | 10-125 | 11-125 CI | 11-125 CIE |
14-125 CI | 14-125 CIE



en Original instructions



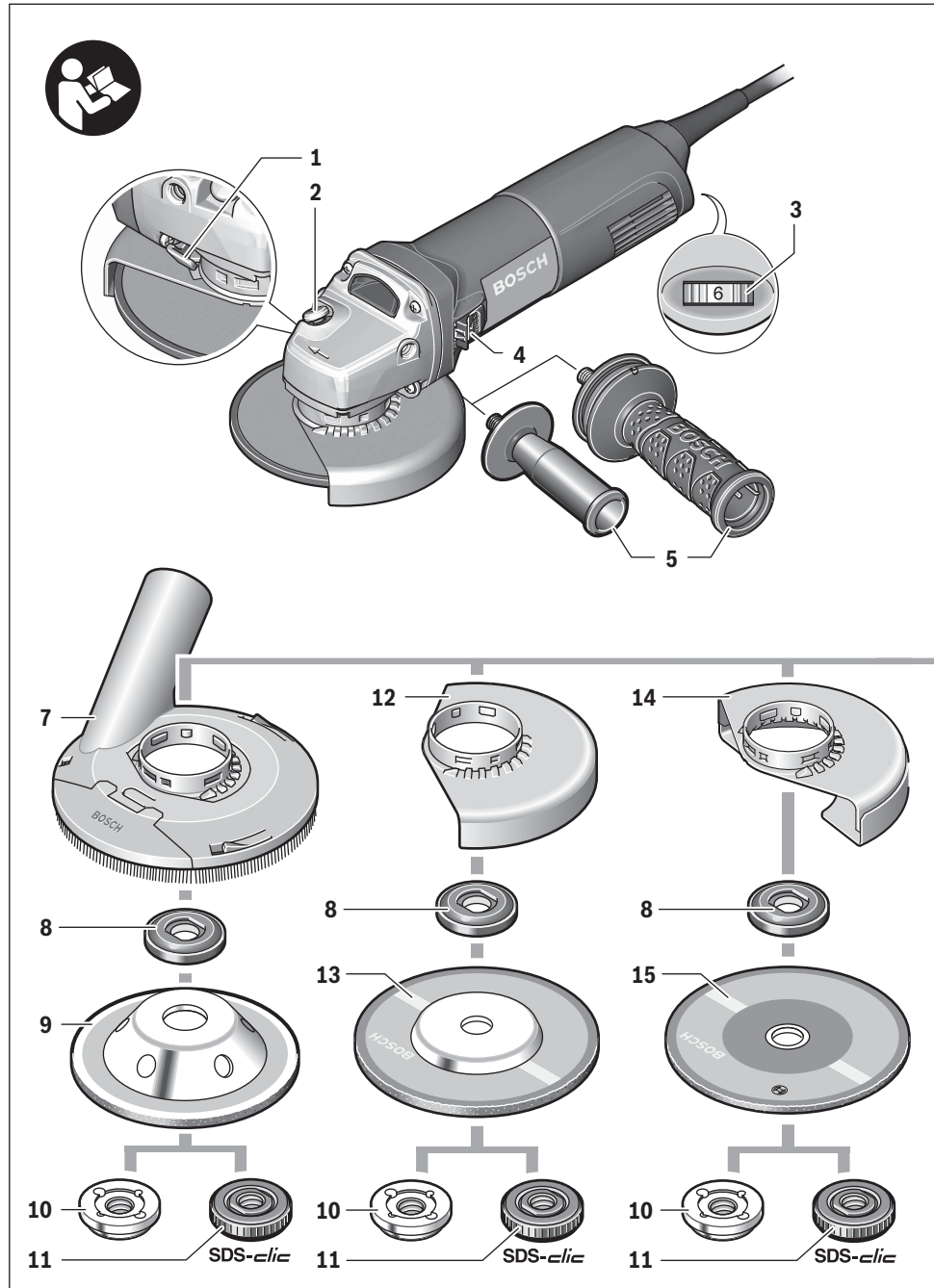

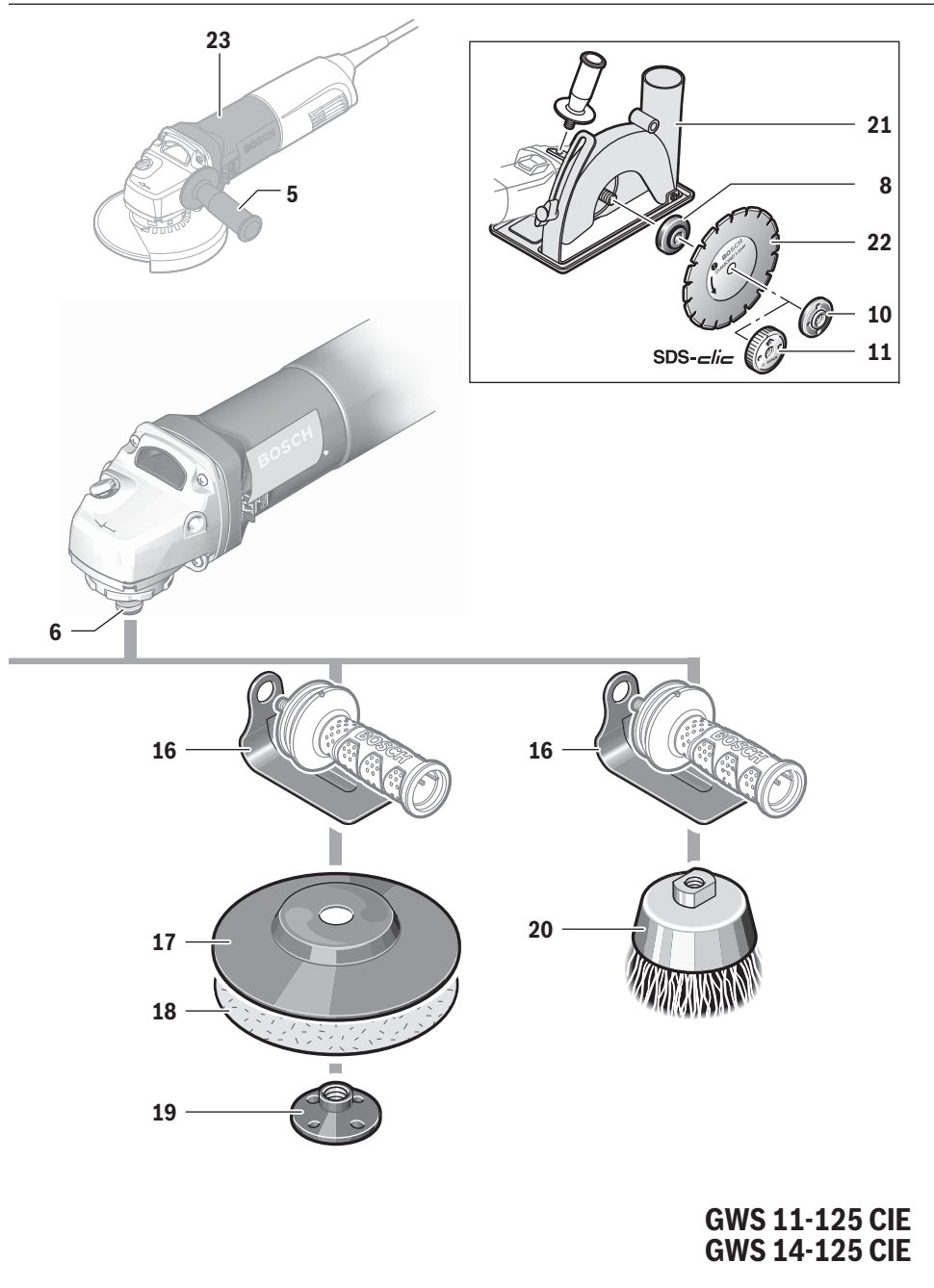

English

Safety Notes

General Power Tool Safety Warnings

⚠ WARNING Read all safety warnings and all instructions. Failure to follow the warnings and instructions may result in electric shock, fire and/or serious injury.

Save all warnings and instructions for future reference. The term "power tool" in the warnings refers to your mains-operated (corded) power tool or battery-operated (cordless) power tool.

Work area safety

- ▶ **Keep work area clean and well lit.** Cluttered or dark areas invite accidents.
- ▶ **Do not operate power tools in explosive atmospheres, such as in the presence of flammable liquids, gases or dust.** Power tools create sparks which may ignite the dust or fumes.
- ▶ **Keep children and bystanders away while operating a power tool.** Distractions can cause you to lose control.

Electrical safety

- ▶ **Power tool plugs must match the outlet. Never modify the plug in any way. Do not use any adapter plugs with earthed (grounded) power tools.** Unmodified plugs and matching outlets will reduce risk of electric shock.
- ▶ **Avoid body contact with earthed or grounded surfaces, such as pipes, radiators, ranges and refrigerators.** There is an increased risk of electric shock if your body is earthed or grounded.
- ▶ **Do not expose power tools to rain or wet conditions.** Water entering a power tool will increase the risk of electric shock.
- ▶ **Do not abuse the cord. Never use the cord for carrying, pulling or unplugging the power tool. Keep cord away from heat, oil, sharp edges and moving parts.** Damaged or entangled cords increase the risk of electric shock.
- ▶ **When operating a power tool outdoors, use an extension cord suitable for outdoor use.** Use of a cord suitable for outdoor use reduces the risk of electric shock.
- ▶ **If operating a power tool in a damp location is unavoidable, use a residual current device (RCD) protected supply.** Use of an RCD reduces the risk of electric shock.

Personal safety

- ▶ **Stay alert, watch what you are doing and use common sense when operating a power tool. Do not use a power tool while you are tired or under the influence of drugs, alcohol or medication.** A moment of inattention while operating power tools may result in serious personal injury.
- ▶ **Use personal protective equipment. Always wear eye protection.** Protective equipment such as dust mask, non-skid safety shoes, hard hat, or hearing protection

used for appropriate conditions will reduce personal injuries.

- ▶ **Prevent unintentional starting. Ensure the switch is in the off-position before connecting to power source and/or battery pack, picking up or carrying the tool.** Carrying power tools with your finger on the switch or energising power tools that have the switch on invites accidents.
- ▶ **Remove any adjusting key or wrench before turning the power tool on.** A wrench or a key left attached to a rotating part of the power tool may result in personal injury.
- ▶ **Do not overreach. Keep proper footing and balance at all times.** This enables better control of the power tool in unexpected situations.
- ▶ **Dress properly. Do not wear loose clothing or jewellery. Keep your hair, clothing and gloves away from moving parts.** Loose clothes, jewellery or long hair can be caught in moving parts.
- ▶ **If devices are provided for the connection of dust extraction and collection facilities, ensure these are connected and properly used.** Use of dust collection can reduce dust-related hazards.

Power tool use and care

- ▶ **Do not force the power tool. Use the correct power tool for your application.** The correct power tool will do the job better and safer at the rate for which it was designed.
- ▶ **Do not use the power tool if the switch does not turn it on and off.** Any power tool that cannot be controlled with the switch is dangerous and must be repaired.
- ▶ **Disconnect the plug from the power source and/or the battery pack from the power tool before making any adjustments, changing accessories, or storing power tools.** Such preventive safety measures reduce the risk of starting the power tool accidentally.
- ▶ **Store idle power tools out of the reach of children and do not allow persons unfamiliar with the power tool or these instructions to operate the power tool.** Power tools are dangerous in the hands of untrained users.
- ▶ **Maintain power tools. Check for misalignment or binding of moving parts, breakage of parts and any other condition that may affect the power tool's operation. If damaged, have the power tool repaired before use.** Many accidents are caused by poorly maintained power tools.
- ▶ **Keep cutting tools sharp and clean.** Properly maintained cutting tools with sharp cutting edges are less likely to bind and are easier to control.
- ▶ **Use the power tool, accessories and tool bits etc. in accordance with these instructions, taking into account the working conditions and the work to be performed.** Use of the power tool for operations different from those intended could result in a hazardous situation.

Service

- ▶ **Have your power tool serviced by a qualified repair person using only identical replacement parts.** This will ensure that the safety of the power tool is maintained.

Safety Warnings for Angle Grinder

Safety Warnings common for Grinding, Sanding, Wire Brushing or Abrasive Cutting Off Operations

- ▶ **This power tool is intended to function as a grinder, sander, wire brush or cut-off tool. Read all safety warnings, instructions, illustrations and specifications provided with this power tool.** Failure to follow all instructions listed below may result in electric shock, fire and/or serious injury.
- ▶ **Operations such as polishing are not recommended to be performed with this power tool.** Operations for which the power tool was not designed may create a hazard and cause personal injury.
- ▶ **Do not use accessories which are not specifically designed and recommended by the tool manufacturer.** Just because the accessory can be attached to your power tool, it does not assure safe operation.
- ▶ **The rated speed of the accessory must be at least equal to the maximum speed marked on the power tool.** Accessories running faster than their rated speed can break and fly apart.
- ▶ **The outside diameter and the thickness of your accessory must be within the capacity rating of your power tool.** Incorrectly sized accessories cannot be adequately guarded or controlled.
- ▶ **Threaded mounting of accessories must match the grinder spindle thread. For accessories mounted by flanges, the arbour hole of the accessory must fit the locating diameter of the flange.** Accessories that do not match the mounting hardware of the power tool will run out of balance, vibrate excessively and may cause loss of control.
- ▶ **Do not use a damaged accessory. Before each use inspect the accessory such as abrasive wheels for chips and cracks, backing pad for cracks, tear or excess wear, wire brush for loose or cracked wires. If power tool or accessory is dropped, inspect for damage or install an undamaged accessory. After inspecting and installing an accessory, position yourself and bystanders away from the plane of the rotating accessory and run the power tool at maximum no-load speed for one minute.** Damaged accessories will normally break apart during this test time.
- ▶ **Wear personal protective equipment. Depending on application, use face shield, safety goggles or safety glasses. As appropriate, wear dust mask, hearing protectors, gloves and shop apron capable of stopping small abrasive or workpiece fragments.** The eye protection must be capable of stopping flying debris generated by various operations. The dust mask or respirator must be capable of filtering particles generated by your operation. Prolonged exposure to high intensity noise may cause hearing loss.
- ▶ **Keep bystanders a safe distance away from work area. Anyone entering the work area must wear personal protective equipment.** Fragments of workpiece or of a broken accessory may fly away and cause injury beyond immediate area of operation.
- ▶ **Hold the power tool by insulated gripping surfaces only, when performing an operation where the cutting accessory may contact hidden wiring or its own cord.** Cutting accessory contacting a "live" wire may make exposed metal parts of the power tool "live" and could give the operator an electric shock.
- ▶ **Position the cord clear of the spinning accessory.** If you lose control, the cord may be cut or snagged and your hand or arm may be pulled into the spinning wheel.
- ▶ **Never lay the power tool down until the accessory has come to a complete stop.** The spinning wheel may grab the surface and pull the power tool out of your control.
- ▶ **Do not run the power tool while carrying it at your side.** Accidental contact with the spinning accessory could snag your clothing, pulling the accessory into your body.
- ▶ **Regularly clean the power tool's air vents.** The motor's fan will draw the dust inside the housing and excessive accumulation of powdered metal may cause electrical hazards.
- ▶ **Do not operate the power tool near flammable materials.** Sparks could ignite these materials.
- ▶ **Do not use accessories that require liquid coolants.** Using water or other liquid coolants may result in electrocution or shock.

Kickback and related warnings

- ▶ **Kickback is a sudden reaction to a pinched or snagged rotating wheel, backing pad, brush or any other accessory.** Pinching or snagging causes rapid stalling of the rotating accessory which in turn causes the uncontrolled power tool to be forced in the direction opposite of the accessory's rotation at the point of the binding.
For example, if an abrasive wheel is snagged or pinched by the workpiece, the edge of the wheel that is entering into the pinch point can dig into the surface of the material causing the wheel to climb out or kick out. The wheel may either jump toward or away from the operator, depending on direction of the wheel's movement at the point of pinching. Abrasive wheels may also break under these conditions.
Kickback is the result of power tool misuse and/or incorrect operating procedures or conditions and can be avoided by taking proper precautions as given below.
- ▶ **Maintain a firm grip on the power tool and position your body and arm to allow you to resist kickback forces. Always use auxiliary handle, if provided, for maximum control over kickback or torque reaction during start-up.** The operator can control torque reactions or kickback forces, if proper precautions are taken.
- ▶ **Never place your hand near the rotating accessory.** Accessory may kickback over your hand.
- ▶ **Do not position your body in the area where power tool will move if kickback occurs.** Kickback will propel the tool in direction opposite to the wheel's movement at the point of snagging.

6 | English

► **Use special care when working corners, sharp edges, etc. Avoid bouncing and snagging the accessory.** Corners, sharp edges or bouncing have a tendency to snag the rotating accessory and cause loss of control or kickback.

► **Do not attach a saw chain woodcarving blade or toothed saw blade.** Such blades create frequent kickback and loss of control.

Safety warnings specific for Grinding and Abrasive Cutting-Off operations

► **Use only wheel types that are recommended for your power tool and the specific guard designed for the selected wheel.** Wheels for which the power tool was not designed cannot be adequately guarded and are unsafe.

► **The grinding surface of the centre depressed wheels must be mounted below the plane of the guard lip.** An improperly mounted wheel that projects through the plane of the guard lip cannot be adequately protected.

► **The guard must be securely attached to the power tool and positioned for maximum safety, so the least amount of wheel is exposed towards the operator.** The guard helps to protect operator from broken wheel fragments, accidental contact with wheel and sparks that could ignite clothing.

► **Wheels must be used only for recommended applications. For example: do not grind with the side of the cut-off wheel.** Abrasive cut-off wheels are intended for peripheral grinding; side forces applied to these wheels may cause them to shatter.

► **Always use undamaged wheel flanges that are of correct size and shape for your selected wheel.** Proper wheel flanges support the wheel thus reducing the possibility of wheel breakage. Flanges for cut-off wheels may be different from grinding wheel flanges.

► **Do not use worn down reinforced wheels from larger power tools.** Wheels intended for larger power tools are not suitable for the higher speed of a smaller tool and may burst.

Additional safety warnings specific for abrasive cutting off operations

► **Do not "jam" the cut-off wheel or apply excessive pressure. Do not attempt to make an excessive depth of cut.** Overstressing the wheel increases the loading and susceptibility to twisting or binding of the wheel in the cut and the possibility of kickback or wheel breakage.

► **Do not position your body in line with and behind the rotating wheel.** When the wheel, at the point of operation, is moving away from your body, the possible kickback may propel the spinning wheel and the power tool directly at you.

► **When wheel is binding or when interrupting a cut for any reason, switch off the power tool and hold the power tool motionless until the wheel comes to a complete stop. Never attempt to remove the cut-off wheel from the cut while the wheel is in motion otherwise kickback may occur.** Investigate and take corrective action to eliminate the cause of wheel binding.

► **Do not restart the cutting operation in the workpiece. Let the wheel reach full speed and carefully re-enter the cut.** The wheel may bind, walk up or kickback if the power tool is restarted in the workpiece.

► **Support panels or any oversized workpiece to minimize the risk of wheel pinching and kickback.** Large workpieces tend to sag under their own weight. Supports must be placed under the workpiece near the line of cut and near the edge of the workpiece on both sides of the wheel.

► **Use extra caution when making a "pocket cut" into existing walls or other blind areas.** The protruding wheel may cut gas or water pipes, electrical wiring or objects that can cause kickback.

Safety warnings specific for sanding operations

► **Do not use excessively oversized sanding disc paper. Follow manufacturers recommendations, when selecting sanding paper.** Larger sanding paper extending beyond the sanding pad presents a laceration hazard and may cause snagging, tearing of the disc, or kickback.

Safety warnings specific for wire brushing operations

► **Be aware that wire bristles are thrown by the brush even during ordinary operation. Do not overstress the wires by applying excessive load to the brush.** The wire bristles can easily penetrate light clothing and/or skin.

► **If the use of a guard is recommended for wire brushing, do not allow any interference of the wire wheel or brush with the guard.** Wire wheel or brush may expand in diameter due to work load and centrifugal forces.

Additional safety warnings

Wear safety goggles.



► **Use suitable detectors to determine if utility lines are hidden in the work area or call the local utility company for assistance.** Contact with electric lines can lead to fire and electric shock. Damaging a gas line can lead to explosion. Penetrating a water line causes property damage or may cause an electric shock.

► **Release the On/Off switch and set it to the off position when the power supply is interrupted, e. g., in case of a power failure or when the mains plug is pulled.** This prevents uncontrolled restarting.

► **Secure the workpiece.** A workpiece clamped with clamping devices or in a vice is held more secure than by hand.

Products sold in GB only: Your product is fitted with a BS 1363/A approved electric plug with internal fuse (ASTA approved to BS 1362).

If the plug is not suitable for your socket outlets, it should be cut off and an appropriate plug fitted in its place by an authorised customer service agent. The replacement plug should have the same fuse rating as the original plug.

The severed plug must be disposed of to avoid a possible shock hazard and should never be inserted into a mains socket elsewhere.

Products sold in AUS and NZ only: Use a residual current device (RCD) with a rated residual current of 30 mA or less.

Product Description and Specifications



Read all safety warnings and all instructions. Failure to follow the warnings and instructions may result in electric shock, fire and/or serious injury.

Intended Use

The machine is intended for cutting, roughing and brushing of metal and stone materials without the use of water.

For cutting with bonded abrasives, a special cutting guard (accessory) must be used.

When cutting in stone, provide for sufficient dust extraction.

With approved sanding tools, the machine can be used for sanding with sanding discs.

Product Features

The numbering of the product features refers to the illustration of the machine on the graphics page.

- 1 Release lever for protection guard
- 2 Spindle lock button
- 3 Thumbwheel for speed preselection
(GWS 11-125 CIE/GWS 14-125 CIE)

- 4 On/Off switch
- 5 Auxiliary handle (insulated gripping surface)
- 6 Grinder spindle
- 7 Extraction hood for sanding*
- 8 Mounting flange with O-ring
- 9 Carbide grinding head*
- 10 Clamping nut
- 11 Quick-clamping nut **SDS-clie** *
- 12 Protection guard for grinding
- 13 Grinding wheel*
- 14 Protection guard for cutting*
- 15 Cutting disc*
- 16 Hand guard*
- 17 Rubber sanding plate*
- 18 Sanding sheet*
- 19 Round nut*
- 20 Cup brush*
- 21 Cutting guide with dust extraction protection guard*
- 22 Diamond cutting disc*
- 23 Handle (insulated gripping surface)

*Accessories shown or described are not part of the standard delivery scope of the product. A complete overview of accessories can be found in our accessories program.

Technical Data

Angle Grinder	GWS ...	8-115	8-125	10-125
Article number	3 601 ...	H20 ...	H27 ...	H21 ...
Rated power input	W	800	800	1000
Output power	W	500	500	630
Rated speed	min ⁻¹	11 000	11 000	11 000
Speed control adjustment	min ⁻¹	-	-	-
Grinding disc diameter, max.	mm	115	125	125
Thread of grinder spindle		M 14	M 14	M 14
Thread length (max.) of grinder spindle	mm	22	22	22
Kickback stop		-	-	-
Restarting Protection		-	-	-
Reduced starting current		-	-	-
Constant electronic control		-	-	-
Speed preselection		-	-	-
Weight according to EPTA-Procedure 01:2014	kg	1.9	1.9	2.1
	kg	1.8	1.8	2.0
Protection class		□/II	□/II	□/II

8 | English

Angle Grinder	GWS ...	11-125 CI	11-125CIE	14-125 CI	14-125 CIE
Article number	3 601 ...	H22 ...	H23 ...	H24 ...	H25 ...
Rated power input	W	1100	1100	1400	1400
Output power	W	660	660	820	820
Rated speed	min ⁻¹	11000	11000	11000	11000
Speed control adjustment	min ⁻¹	- 2800 - 11000		- 2800 - 11000	
Grinding disc diameter, max.	mm	125	125	125	125
Thread of grinder spindle		M 14	M 14	M 14	M 14
Thread length (max.) of grinder spindle	mm	22	22	22	22
Kickback stop		●	●	●	●
Restarting Protection		●	●	●	●
Reduced starting current		●	●	●	●
Constant electronic control		●	●	●	●
Speed preselection		-	●	-	●
Weight according to EPTA-Procedure 01:2014	kg	2.0	2.0	2.2	2.2
	kg	1.9	1.9	2.1	2.1
Protection class		□/II	□/II	□/II	□/II

The values given are valid for a nominal voltage [U] of 230 V. For different voltages and models for specific countries, these values can vary.

Assembly

Mounting the Protective Devices

- **Before any work on the machine itself, pull the mains plug.**

Note: After breakage of the grinding disc during operation or damage to the holding fixtures on the protection guard/power tool, the machine must promptly be sent to an after-sales service agent for maintenance for addresses, see section "After-sales Service and Application Service".

Protection Guard for Grinding

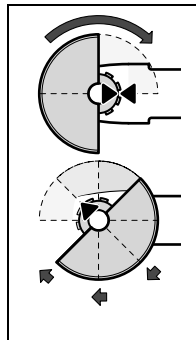

Place the protection guard **12** onto the spindle collar as shown in the illustration. The triangle marks on the protection guard must correspond with the respective marks on the gear case.

Press the protection guard **12** onto the spindle collar until the shoulder of the protection guard is seated against the flange of the machine, and turn the protection guard until it can clearly be heard to engage.

Adjust the position of the protection guard **12** to the requirements of the work process. For this, press the release lever **1** upward and turn the protection guard **12** to the required position.

- **Adjust the protection guard 12 in such a manner that sparking is prevented in the direction of the operator.**
- **The protection guard 12 may be turned only upon actuation of the release lever 1! Otherwise the power tool**

may not continue to be used under any circumstances and must be taken to an after-sales service agent.

Note: The encoding keys on the protection guard **12** ensure that only a protection guard that fits the machine type can be mounted.

Protection Guard for Cutting

- **For cutting with bonded abrasives, always use the protection guard for cutting 14.**
- **Provide for sufficient dust extraction when cutting stone.**

The protection guard for cutting **14** is mounted in the same manner as the protection guard for grinding **12**.

Cutting Guide with Dust Extraction Protection Guard

The cutting guide with dust extraction protection guard **21** is mounted in the same manner as the protection guard for grinding **12**.

Extraction Hood for Sanding

The extraction hood **7** can be used for low-dust sanding of paint, varnish and plastics in conjunction with the carbide grinding head **9** or the rubber sanding plate **17** with a sanding sheet **18**. The extraction hood **7** is not suitable for working metals.

A suitable Bosch vacuum cleaner can be connected to the extraction hood **7**.

The extraction hood **7** is mounted in the same manner as the protection guard **12**. The brush collar is exchangeable.

Auxiliary Handle

- ▶ **Operate your machine only with the auxiliary handle 5.**
- Screw the auxiliary handle **5** on the right or left of the machine head depending on the working method.

Hand Guard

- ▶ **For operations with the rubber sanding plate 17 or with the cup brush/wheel brush/flap disc, always mount the hand guard 16.**
- The hand guard **16** is fastened with the auxiliary handle **5**.

Mounting the Grinding Tools

- ▶ **Before any work on the machine itself, pull the mains plug.**
- ▶ **Do not touch grinding and cutting discs before they have cooled down.** The discs can become very hot while working.
- Clean the grinder spindle **6** and all parts to be mounted.
- For clamping and loosening the grinding tools, lock the grinder spindle with the spindle lock button **2**.
- ▶ **Actuate the spindle lock button only when the grinder spindle is at a standstill.** Otherwise, the machine may become damaged.

Grinding/Cutting Disc

Pay attention to the dimensions of the grinding tools. The mounting hole diameter must fit the mounting flange without play. Do not use reducers or adapters.

When using diamond cutting discs, pay attention that the direction-of-rotation arrow on the diamond cutting disc and the direction of rotation of the machine (see direction-of-rotation arrow on the machine head) agree.

See graphics page for the mounting sequence.

- To fasten the grinding/cutting disc, screw on the clamping nut **10** and tighten with the two-pin spanner; see Section "Quick-clamping Nut".
- ▶ **After mounting the grinding tool and before switching on, check that the grinding tool is correctly mounted and that it can turn freely. Make sure that the grinding tool does not graze against the protection guard or other parts.**

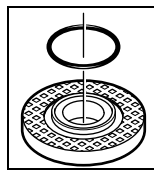

A plastic part (O-ring) is fitted around the centring collar of mounting flange **8**. **If the O-ring is missing or damaged, the mounting flange 8 must be replaced before resuming operation.**

Flap Disc

- ▶ **For operations with the flap disc, always mount the hand guard 16.**

Rubber Sanding Plate

- ▶ **For operations with the rubber sanding plate 17, always mount the hand guard 16.**

See graphics page for the mounting sequence.

- Screw on the round nut **19** and tighten with the two-pin spanner.

Cup Brush/Disc Brush

- ▶ **For operations with the cup brush/wheel brush, always mount the hand guard 16.**

See graphics page for the mounting sequence.

The cup brush/disc brush must be able to be screwed onto the grinder spindle until it rests firmly against the grinder spindle flange at the end of the grinder spindle threads. Tighten the cup brush/disc brush with an open-end spanner.

Quick-clamping Nut SDS-clic

For convenient changing of grinding tools without the use of additional tools, you can use the quick-clamping nut **11** instead of the clamping nut **10**.

- ▶ **The quick-clamping nut 11 may be used only for grinding or cutting discs.**

Use only a flawless, undamaged quick-clamping nut 11.

When screwing on, pay attention that the side of the quick-clamping nut 11 with printing does not face the grinding disc; the arrow must point to the index mark 24.

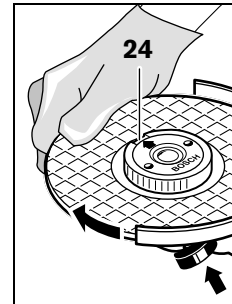

Lock the grinder spindle with the spindle lock button **2**. To tighten the quick-clamping nut, firmly turn the grinding disc in clockwise direction.

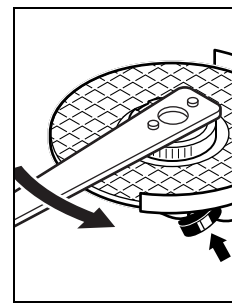

A properly attached, undamaged quick-clamping nut can be loosened by hand when turning the knurled ring in anticlockwise direction. **Never loosen a tight quick-clamping nut with pliers. Always use the two-pin spanner.** Insert the two-pin spanner as shown in the illustration.





10 | English

Approved Grinding Tools

All grinding tools mentioned in these operating instructions can be used.

The permissible speed [min^{-1}] or the circumferential speed [m/s] of the grinding tools used must at least match the values given in the table.

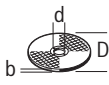
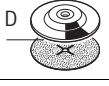
Therefore, observe the permissible **rotational/circumferential speed** on the label of the grinding tool.

	max. [mm]		[mm]	 [min^{-1}]	 [m/s]
	D	b			
	115	6	22.2	11000	80
	125	6	22.2	11000	80
	150	6	22.2	19300	80
	115	-	-	11000	80
	125	-	-	11000	80
	75	30	M 14	11000	45

Rotating the Machine Head

- **Before any work on the machine itself, pull the mains plug.**

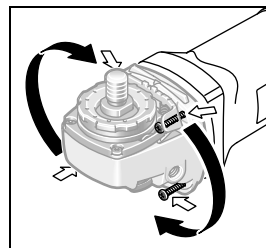

The machine head can be rotated with respect to the machine housing in 90° steps. In this manner, the On/Off switch can be brought into a more convenient position for special working situations, e. g., for cutting operations using the cutting guide with dust

extraction protection guard **21** or for left-handed persons.

Completely unscrew the four screws. Rotate the machine head carefully, **without removing it from the housing**, to the new position. Screw in and tighten the four screws again.

Dust/Chip Extraction

- Dusts from materials such as lead-containing coatings, some wood types, minerals and metal can be harmful to one's health. Touching or breathing-in the dusts can cause allergic reactions and/or lead to respiratory infections of the user or bystanders.

Certain dusts, such as oak or beech dust, are considered as carcinogenic, especially in connection with wood-treatment additives (chromate, wood preservative). Materials containing asbestos may only be worked by specialists.

- As far as possible, use a dust extraction system suitable for the material.
- Provide for good ventilation of the working place.
- It is recommended to wear a P2 filter-class respirator.

Observe the relevant regulations in your country for the materials to be worked.

- **Prevent dust accumulation at the workplace.** Dusts can easily ignite.

Operation**Starting Operation**

- **Observe correct mains voltage! The voltage of the power source must agree with the voltage specified on the nameplate of the machine. Power tools marked with 230 V can also be operated with 220 V.**
- **Hold power tool by insulated gripping surfaces 23 and auxiliary handle 5 only. The accessory may contact hidden wiring or its own cord.** Accessory contacting a "live" wire may make exposed metal parts of the power tool "live" and shock the operator.

When operating the machine with power from mobile generators that do not have sufficient reserve capacity or are not equipped with suitable voltage control with starting current amplification, loss of performance or untypical behavior can occur upon switching on.

Please observe the suitability of the power generator being used, particularly with regard to the mains voltage and frequency.

Switching On and Off

- To **start** the power tool, push the On/Off switch **4** forwards.
- To **lock** the On/Off switch **4**, press the On/Off switch **4** down at the front until it latches.
- To **switch off** the power tool, release the On/Off switch **4** or, if it is locked, briefly push down the back of the On/Off switch **4** and then release it.

To save energy, only switch the power tool on when using it.

- **Check grinding tools before using. The grinding tool must be mounted properly and be able to move freely. Carry out a test run for at least one minute with no load. Do not use damaged, out-of-centre or vibrating grinding tools.** Damaged grinding tools can burst and cause injuries.

Kickback stop

(GWS 11-125 CI/GWS 11-125 CIE/GWS 14-125 CI/GWS 14-125 CIE)

KICK BACK STOP

In case of a sudden drop in speed, e.g., caused by a jammed disc while cutting, the power supply to the motor is electronically interrupted.

To **restart the operation**, switch the On/Off switch **4** to the Off position and start the machine again.

Restarting Protection

(GWS 11-125 CI/GWS 11-125 CIE/GWS 14-125 CI/GWS 14-125 CIE)

The restarting protection feature prevents uncontrolled restarting of the machine after an interruption in the power supply.

To **restart the operation**, switch the On/Off switch **4** to the Off position and start the machine again.

Reduced starting current
(GWS 11-125 CI/GWS 11-125 CIE/
GWS 14-125 CI/GWS 14-125 CIE)

The electronic reduced starting current limits the power consumption when switching the tool on and enables operation from a 13 ampere fuse.

Constant Electronic Control
(GWS 11-125 CI/GWS 11-125 CIE/
GWS 14-125 CI/GWS 14-125 CIE)

Constant electronic control holds the speed constant at no-load and under load, and ensures uniform working performance.

Speed preselection (GWS 11-125 CIE/GWS 14-125 CIE)

The required speed can be preselected with the thumbwheel **3** (also while running).

The data in the following table are recommended values.

Material	Application	Accessory	Thumbwheel Position
Metal	Removing paint	Sanding disc	2 – 3
Wood, metal	Brushing, rust removal	Cup brush, sanding disc	3
Metal, masonry	Grinding	Grinding disc	4 – 6
Metal	Rough grinding	Grinding disc	6
Masonry, stone	Cutting	Cutting disc and cutting guide (Cutting masonry/stone is permitted only with use of the cutting guide)	6

Working Advice

- ▶ **Exercise caution when cutting slots in structural walls; see Section “Information on Structures”.**
- ▶ **Clamp the workpiece if it does not remain stationary due to its own weight.**
- ▶ **Do not strain the machine so heavily that it comes to a standstill.**
- ▶ **After heavily straining the power tool, continue to run it at no-load for several minutes to cool down the accessory.**
- ▶ **Do not touch grinding and cutting discs before they have cooled down.** The discs can become very hot while working.
- ▶ **Do not use the power tool with a cut-off stand.**

Rough Grinding

- ▶ **Never use a cutting disc for roughing.**

The best roughing results are achieved when setting the machine at an angle of 30° to 40°. Move the machine back and forth with moderate pressure. In this manner, the workpiece will not become too hot, does not discolour and no grooves are formed.

Flap Disc

With the flap disc (accessory), curved surfaces and profiles can be worked.

Flap discs have a considerably higher service life, lower noise levels and lower sanding temperatures than conventional sanding sheets.

Cutting Metal

- ▶ **For cutting with bonded abrasives, always use the protection guard for cutting **14**.**

When cutting, work with moderate feed, adapted to the material being cut. Do not exert pressure onto the cutting disc, tilt or oscillate the machine.

Do not reduce the speed of running down cutting discs by applying sideward pressure.

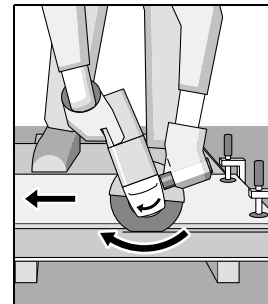

The machine must always work in an up-grinding motion. Otherwise, the danger exists of it being pushed **uncontrolled** out of the cut.

When cutting profiles and square bar, it is best to start at the smallest cross section.

Cutting Stone

- ▶ **Provide for sufficient dust extraction when cutting stone.**
- ▶ **Wear a dust respirator.**
- ▶ **The machine may be used only for dry cutting/grinding.**

For cutting stone, it is best to use a diamond cutting disc.

When using the cutting guide with dust extraction protection guard **21**, the vacuum cleaner must be approved for vacuuming masonry dust. Suitable vacuum cleaners are available from Bosch.

12 | English

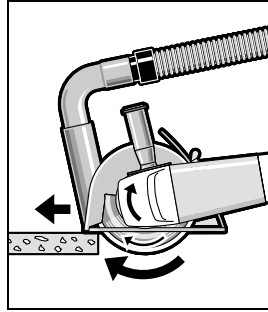

Switch on the machine and place the front part of the cutting guide on the workpiece. Slide the machine with moderate feed, adapted to the material to be worked.

For cutting especially hard material, e. g., concrete with high pebble content, the diamond cutting disc can overheat and become damaged as a result. This is clearly indicated by circular sparking, rotating with the diamond cutting disc. In this case, interrupt the cutting process and allow the diamond cutting disc to cool by running the machine for a short time at maximum speed with no load.

Noticeable decreasing work progress and circular sparking are indications of a diamond cutting disc that has become dull. Briefly cutting into abrasive material (e. g. lime-sand brick) can resharpen the disc again.

Information on Structures

Slots in structural walls are subject to the Standard DIN 1053 Part 1, or country-specific regulations. These regulations are to be observed under all circumstances. Before beginning work, consult the responsible structural engineer, architect or the construction supervisor.

Maintenance and Service

Maintenance and Cleaning

- ▶ **Before any work on the machine itself, pull the mains plug.**
- ▶ **For safe and proper working, always keep the machine and ventilation slots clean.**
- ▶ **In extreme conditions, always use dust extraction as far as possible. Blow out ventilation slots frequently and install a residual current device (RCD).** When working metals, conductive dust can settle in the interior of the power tool. The total insulation of the power tool can be impaired.

If the replacement of the supply cord is necessary, this has to be done by Bosch or an authorized Bosch service agent in order to avoid a safety hazard.

Please store and handle the accessory(-ies) carefully.

After-sales Service and Application Service

In all correspondence and spare parts order, please always include the 10-digit article number given on the type plate of the machine.

Our after-sales service responds to your questions concerning maintenance and repair of your product as well as spare parts. Exploded views and information on spare parts can also be found under:

www.bosch-pt.com

Bosch's application service team will gladly answer questions concerning our products and their accessories.

India

Bosch Service Center
67, Mathiravedu, Velappan Chavdy, Ponamalle High Road,
Numbal Village
Chennai – 600077
Phone: (044) 64561816

Bosch Service Center
Rishyamook, 85A, Panchkuin Road
Delhi – 110001
Phone: (011) 43166190

Bosch Service Center
41, 41A, Appa Baug Bldg, Maharshi Karve Marg, Opp Charni
Road Station
Mumbai – 400002
Phone: (022) 22014649

Disposal

The machine, accessories and packaging should be sorted for environmental-friendly recycling.

Do not dispose of power tools into household waste!

Subject to change without notice.

