

Robert Bosch Power Tools GmbH
70538 Stuttgart
GERMANY

www.bosch-do-it.com

1 609 92A 3EN (2017.07) 0 / 66 91954 ET



1 609 92A 3EN

GHP 8-15 XD

 **BOSCH**

- en Original instructions
- cn 正本使用说明书
- tw 原始使用說明書
- ko 사용 설명서 원본
- th หนังสือคู่มือการใช้งานฉบับต้นแบบ
- id Petunjuk-Petunjuk untuk Penggunaan Orisinal
- vi Bản gốc hướng dẫn sử dụng





2 |



English Page 3
 中文 页 13
 中文 頁 19
 한국어 페이지 26
 ภาษาไทย หน้า 33
 Bahasa Indonesia Halaman 41
 Tiếng Việt Trang 50

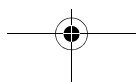
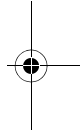

English

Safety Notes

Explanation of symbols



General hazard safety alert.



Never direct the water jet at people, animals, the unit or electric components.

Warning: High pressure jets can be dangerous if subject to misuse.



According to the applicable regulations, the appliance must never be used on the drinking water network without a system separator. Use a separator as per IEC 61770 Type BA.

Water flowing through a system separator is considered not drinkable. For self priming use special suction kit 3 m long (F 016 800 335).

Safety Notes for pressure washer



Read all safety warnings and all instructions. Failure to follow the warnings and instructions may result in electric shock, fire and/or serious injury.

The warning and information signs attached to the unit provide important information for safe operation. Apart from the information in the operating instructions comply with the general safety regulations and regulations for the prevention of accidents.

Connecting to the mains

- ▶ The voltage indicated on the rating plate must correspond to the voltage of the power source.
- ▶ We recommend that this equipment is only connected into a socket which is protected by a circuit-breaker that would be actuated by a 30 mA residual current.
- ▶ This is a class I unit and may only be connected to properly earthed power sources.
- ▶ Remove the plug from socket whenever the machine is left unattended for any period.
- ▶ The electric supply installation should comply with IEC 60364-1.
- ▶ If the supply cord is damaged, it must be replaced by the manufacturer, its service agent or similarly qualified persons in order to avoid a hazard.
- ▶ If the plug is damaged, pay attention to the following:
 - ▶ Plugs and sockets situated near the work site or outdoors should be to class IP 55 of BS 5490 to provide adequate protection against ingress of water, etc. and cable entries require effective sealing. Rubber shrouds should be provided over cable glands. Drip-proof (class IP X2 of BS 5490) plugs and sockets to BS 4343 are suitable for use indoors where the plug is away from the water spray area where the appliance is in use.
 - ▶ Never touch the mains plug with wet hands.

4 | English

- ▶ Do not pull plug while operating the device.
- ▶ Do not run over, crush or pull the power supply cord or extension cord, otherwise it may be damaged. Protect the cable from heat, oil and sharp edges.
- ▶ Do not use the unit, if the power supply cord or important parts, e. g. high-pressure hose, power gun or safety devices are damaged.
- ▶ Warning: Inadequate extension cords can be dangerous.
- ▶ If an extension cord is used, the plug and socket must be of watertight construction. The extension cord must have a cross section in accordance with the operating instructions and be protected against splashed water. The connection must not be in water.
- ▶ When replacing plugs on the power supply cable or extension lead the spray water guard and mechanical stability must remain intact.

Water connection

- ▶ Comply with the regulations of your water supply company.
- ▶ All connecting hoses must have properly sealed joints.
- ▶ The appliance should never be used on the drinking water supply without a back flow valve. Water which has passed the back flow valve is regarded as undrinkable.
- ▶ The high-pressure hose must not be damaged (danger of bursting). A damaged high-pressure hose must be replaced immediately. Only use hoses

and connections recommended by the manufacturer.

- ▶ High-pressure hoses, fittings and couplings are important for the safety of the appliance. Use only hoses, fittings and couplings recommended by the manufacturer.
- ▶ Only clean or filtered water should be used for intake.

Application

- ▶ Before use, check that the unit and operating equipment are in perfect condition and are safe to operate. Do not use the unit if it is not in perfect condition.
- ▶ Do not direct the jet against yourself or others in order to clean clothes or footwear.
- ▶ Do not use solvent-containing liquids, undiluted acids, acetone or solvents! This includes petrol, paint thinners, heating oil. The sprayed vapour is highly flammable, explosive and toxic.
- ▶ The appropriate safety regulations must be observed when using the unit in dangerous areas (e. g. petrol stations). It is forbidden to operate the unit in potentially explosive locations.
- ▶ The unit must be placed on a solid base.
- ▶ Take care if using the machine in a confined space ensuring that there is adequate ventilation. Ensure that all vehicles are switched off at all times whilst cleaning.
- ▶ Operation of this machine requires both hands to be used at all times. Do not operate from a ladder. Take care

- when using the machine on balconies or other raised areas ensuring that you can see any edges at all times.
- ▶ Only use detergents recommended by the manufacturer. Comply with the application, disposal and warning instructions of the detergent manufacturers.
 - ▶ All current-conducting components in the working area must be protected against splashed water.
 - ▶ The gun trigger must not be jammed in position "ON" during operation.
 - ▶ Wear suitable protective clothing to protect against splash water. Do not use the machine in reach of persons, unless these are also wearing protective clothing.
 - ▶ If necessary wear personal protective equipment (PPE) e. g. safety goggles, breathing protection etc to protect against water, particles and/or aerosols sprayed back from parts.
 - ▶ **During use of high pressure cleaners, aerosols may be formed.** Inhalation of aerosols can be hazardous to health.
 - ▶ High pressure may cause objects to rebound. If necessary wear suitable personnel protective equipment such as safety goggles.
 - ▶ Vehicle tyres/tyre valves may only be cleaned from a minimum distance of 30 cm in order to avoid damages by the high-pressure jet. The first indication of damage is the discolouration of the tyre. Damaged vehicle tyres/tyre valves are dangerous to life.
 - ▶ Materials containing asbestos and other materials which contain substances which are hazardous to your health must not be sprayed.
 - ▶ Detergents must not be used undiluted. The products are safe to use as they contain no acids, alkalis or substances which are detrimental to the environment. We recommend that the detergents are kept out of the reach of children. If detergent comes into contact with the eyes, wash immediately with plenty of water and if swallowed contact a doctor immediately.
 - ▶ **Never use the power washer without water filter, or with a contaminated or damaged water filter.** Using the power washer without water filter or with a contaminated or damaged water filter shall void the warranty.
 - ▶ Metal parts may become hot after prolonged usage, if necessary wear protective gloves.
 - ▶ Avoid high pressure washing in bad weather conditions especially when there is a risk of lightning.

Operation

- ▶ The operator must use the unit in accordance with the regulations. He/she must take local conditions into account and be aware of other people, especially children, when operating the unit.
- ▶ The unit may only be used by authorised persons who have received training or have demonstrated their ability to operate the unit. The unit must not be operated by children or

6 | English

juveniles (danger of accidents due to incorrect use of the unit).

- ▶ Never allow children, persons with physical, sensory or mental limitations or a lack of experience and/or knowledge and/or people unfamiliar with these instructions to use the machine. Local regulations may restrict the age of the operator.
- ▶ Children should be supervised to ensure that they do not play with the machine.
- ▶ The unit must never be left unsupervised while the unit is switched on.
- ▶ The water jet from the high-pressure nozzle produces a recoil on the gun. You should therefore hold the gun and spray lance firmly with both hands.

Transport

- ▶ Switch off the motor and secure the unit before transporting.

Maintenance





- ▶ Switch off the unit prior to all cleaning and maintenance work and before replacing components. Pull out the mains plug if the unit is mains-operated.
- ▶ Repairs may only be carried out by authorised Bosch Service Centres.

Accessories and spare parts

- ▶ Accessories and spare parts which have been approved by Bosch must be used. Original accessories and spare parts guarantee that the unit can be operated safely and without any breakdowns.

Symbols

The following symbols are important for reading and understanding the operating instructions. Please take note of the symbols and their meaning. The correct interpretation of the symbols will help you to use the machine in a better and safer manner.

Symbol	Meaning
	Movement direction
	Weight
	On
	Off
Lo	Low pressure
Hi	High pressure
	Accessories

Intended Use

The product is intended for cleaning areas and objects outside the house, tools, vehicles and boats, if the appropriate accessories such as cleaning agents approved by Bosch are used.

Intended use is related to operation within 0°C and 40°C ambient temperature.

Technical Data

Pressure washer	GHP 8-15 XD	
Article number		3 600 J10 3..
Rated power	kW	4
Supply temperature max.	°C	50
Supply rate min.	l/min	12.6
Rated pressure	MPa	15
Max. operating pressure	MPa	16
Rated Flow	l/min	12.6
Maximum inlet pressure	MPa	1
Kickback force at the gun to the maximum pressure	N	33.24
Motor insulation		Class F
Motor protection		IPX5
Detergent tank		I
Autostop function		●
Net impedance		-

The values given are valid for a nominal voltage [U] of 230 V. For different voltages and models for specific countries, these values can vary.

Starting cycles generate brief voltage drops. Interference with other equipment/machines may occur in case of unfavourable mains system conditions. Malfunctions are not to be expected for system impedances below 0.153 ohm.

Pressure washer		GHP 8-15 XD
Sound pressure level	dB(A)	85.5
Uncertainty	dB(A)	3
Sound power level	dB(A)	93
Uncertainty	dB(A)	3
Vibration total value	m/s ²	4.91
Uncertainty	m/s ²	1.5
Weight according to EPTA-Procedure 01:2014	kg	40.6
Protection class		⊕ / I
Serial number	See serial number (rating plate) on pressure washer.	

The values given are valid for a nominal voltage [U] of 230 V. For different voltages and models for specific countries, these values can vary.

Starting cycles generate brief voltage drops. Interference with other equipment/machines may occur in case of unfavourable mains system conditions. Malfunctions are not to be expected for system impedances below 0.153 ohm.

Mounting and Operation

Action	Figure	Page
Delivery Scope	1	59
Handle Assembly	2	60
Mounting the hose	3	61
Insert dip stick for ventilation	4	62
Filling up detergent tank	5	62
Connecting to the water supply	6	63
Clean the water filter	7	63
Connecting high pressure water supply hose/nozzle	8	64
Adjust water pressure	9	64
Adjust water jet	10	65
Switching On and Off	11	65
Clean nozzle	12	65

Starting

For Your Safety



Warning! Switch off, remove plug from mains before adjusting, cleaning or if cable is cut, damaged or entangled.

Your machine is double insulated for safety and requires no earth connection. The operating voltage is 230 V AC, 50 Hz (for non-EU countries 220 V, 240 V as applicable).

For increased electrical safety use a Residual Current Device (RCD) with a tripping current of not more than 30 mA. Always check your RCD every time you use it.

The supply cables must be inspected for signs of damage at regular intervals and may only be used if in perfect condition.

If the replacement of the supply cord is necessary, this has to be done by Bosch or an authorized Bosch service agent in order to avoid a safety hazard.

Only use approved extension cables.



WARNING! Inadequate extension cables can be dangerous. Extension cable, plug and socket must be of watertight construction and intended for outdoor use.

Extension cords, cables, leads, reels should only be used if they comply with EN 61242/IEC 61242 or IEC 60884-2-7.

If you want to use an extension cable when operating your product, only the following cable dimensions should be used:

- Nominal Conductor Area of 1.5 mm² to a max. cable length of 20m for a Cord Extension Set

The connections (plugs and sockets) should be kept dry and off the ground.

It is recommended that this is accomplished by means of a cord reel which keeps the socket at least 60 mm above the ground.

Note: If an extension cable is used it must be earthed and connected through the plug to the earth cable of your supply network in accordance with prescribed safety regulations.

Refer to the instruction manual of the extension cord, lead, reel manufacturer and your local wiring regulations.

If in doubt contact a qualified electrician or the nearest Bosch Service Centre.

For products **not sold in GB:**

WARNING: For your safety, it is required that the plug attached to the product is connected with the extension cord. The coupling of the extension cord must be protected against splash water, be made of rubber or coated with rubber. The extension cord must be used with a cable strain relief.

Products sold in GB only: Your product is fitted with a BS 1363/A approved electric plug with internal fuse (ASTA approved to BS 1362).

If the plug is not suitable for your socket outlets, it should be cut off and an appropriate plug fitted in its place by an authorised customer service agent. The replacement plug should have the same fuse rating as the original plug.

The severed plug must be disposed of to avoid a possible shock hazard and should never be inserted into a mains socket elsewhere.

Products sold in AUS and NZ only: Use a residual current device (RCD) with a rated residual current of 30 mA or less.

Drawing in water from open reservoirs

- Screw the suction hose with filter (special suction kit part no. F 016 800 335) to the water connection.
- Switch on the appliance in low pressure mode.
- Let the appliance run for appx. 10 seconds, then switch off. Repeat the procedure a couple of times until water exiting is smooth and bubble free.

To prevent damage to the appliance, do not allow it to operate dry.

8 | English

Operation

Starting

Attach water supply hose (not supplied) to the mains water supply and machine.

Connect the product to the mains supply ensuring that the mains switch is in the off position.

Open water tap.

Press the safety lock to release the trigger. Fully press the trigger until there is a constant flow of water to clear the air from the machine and water supply hose. Release trigger.

Point the power gun downwards. Press the trigger safety lock to release the trigger. Fully press the trigger.

Operate on/off switch.

Autostop function

The machine is designed to switch off the motor when the trigger is released on the gun.

Working Advice

General

Ensure that the pressure washer is on level ground.

Do not overreach with the high pressure hose or move the pressure washer by pulling the hose, this could cause the machine to become unstable and fall over.

Do not kink or drive a motor vehicle over the high pressure hose. Do not expose the high pressure hose to sharp edges or corners.

Never use a roto nozzle to clean motor vehicles.

Do not tamper with or adjust the safety valve setting.

Dip stick

The pressure washer is delivered with an oil cap for storing the product, and an oil ventilated cap with an oil dip stick, to be used when the product is operated.

Working advice for cleaning with detergents

► **Only use cleaning agents suitable specifically for high pressure washers.**

We recommend that you use detergent sparingly for the sake of the environment. Observe the recommended dilution on the detergent label.

By offering you an individualised range of cleaning and preserving agents, Bosch guarantees troublefree operation of the unit.

Recommended cleaning method

Step 1: Loosening dirt

Spray on detergent sparingly and allow to react for a short time.

Step 2: Removing dirt

Spray off the loosened dirt with the high-pressure spray.

Note: When cleaning vertical surfaces, apply the detergent from bottom to top. When rinsing off, work from top to bottom.

Troubleshooting

Problem	Possible Cause	Corrective Action
Motor refuses to start	Plug not connected	Connect plug
	Mains socket faulty	Use another socket
	Fuse faulty/blown	Replace fuse
	Extension cable damaged	Try without extension cable
	Motor protector has activated	Allow to cool for 15 minutes
Motor stops	Frozen	Wait for pump/water supply hose/accessory to thaw
	Fuse faulty/blown	Replace fuse
	Wrong mains voltage	Check that mains voltage corresponds to specifications on the model tag
Fuses blow	Motor protector has activated	Allow to cool for 15 minutes
	Fuses incorrectly rated	Change to a mains supply higher than the pressure washer amp consumption
Motor starts but no pressure	Nozzle partly blocked	Clean nozzle

Problem	Possible Cause	Corrective Action
Motor "sounds" but fails to start	Insufficient power supply	Check that the voltage of the mains power supply line is the same as that on the plate
	Voltage loss due to use of extension cable	Check characteristics of extension cable
	Appliance not used for a long period of time	Contact your Bosch Service Centre
Pressure pulsating	Problems with TSS (Total Stop System) device	Contact your Bosch Service Centre
	Air in the inlet water supply hose/pump	Allow pressure washer to run with open spray handle and nozzle at low pressure until regular working pressure is obtained
	Inadequate water supply	Check that the water supply corresponds to specifications. The minimum specification for the water supply hose is 1/2" or 13 mm diameter
	Water filter blocked	Clean water filter
	Water supply hoses squeezed	Straighten out kinked water supply hoses
Pressure too low, but steady Note: Several types of accessory will normally deliver a lower pressure	High pressure hose too long	Remove high pressure extension hose. Retry (extension hose max. 7 m)
	Nozzle worn	Change the nozzle
	Start/stop valve worn	Activate trigger five times in quick succession
	Motor starts up but with restricted or no working pressure	Connect water supply
The pressure washer starts irregularly by itself	Water filter clogged up	Clean the water filter
	Nozzle clogged up	Clean nozzle
Water leaks from machine	Pump/spray gun leaky	Contact your Bosch Service Centre
	Leaking pump	A slight water leak is permissible; in case of excessive leak, contact Bosch Service Centre
No detergent taken in	Adjustable nozzle on high pressure setting	Set nozzle on "Lo" setting
	Detergent too dense	Dilute with water
	High pressure hose extension being used	Fit original hose
	Deposits or restriction in detergent circuit	Flush with clean water and eliminate any restrictions. If the problem persists, contact your Bosch Service Centre.

Maintenance and Service

Maintenance

- **Stop, remove plug from the power supply and disconnect from water supply.**

Note: To ensure long and reliable service, carry out the following maintenance regularly.

Regularly check for obvious defects such as loose fixings, and worn or damaged components.

Check that covers and guards are undamaged and correctly fitted. Carry out necessary maintenance or repairs before using.

Transport

To move the pressure washer use the top handle and roll the pressure washer on the wheels.

To transport the pressure washer up or down steps or over obstacles, it must be lifted by the top handle.

After use/Storage

Clean the exterior of the machine thoroughly using a soft brush or cloth. Do not use water, solvents or polishes. Remove all debris, especially from the ventilation slots.

End of season storage: Drain water out of pump running motor for a few seconds. Pull trigger to release all water.

Do not place other objects on top of the machine.

Ensure cables are not trapped when storing. Do not kink high pressure hose.

10 | English

After-sales Service and Application Service**www.bosch-do-it.com**

In all correspondence and spare parts orders, please always include the 10-digit article number given on the type plate of the machine.

Cambodia

Robert Bosch (Cambodia) Co., Ltd
Unit 8BC, GT Tower, 08th Floor, Street 169,
Czechoslovakia Blvd, Sangkat Veal Vong
Khan 7 Makara, Phnom Penh
VAT TIN: 100 169 511
Tel.: +855 23 900 685
Tel.: +855 23 900 660
www.bosch.com.kh

People's Republic of China**China Mainland**

Bosch Power Tools (China) Co., Ltd.
567, Bin Kang Road
Bin Jiang District 310052
Hangzhou, P. R. China
Tel.: 4008268484
Fax: (0571) 87774502
E-Mail: contact.ptcn@cn.bosch.com
www.bosch-pt.com.cn

HK and Macau Special Administrative Regions

Robert Bosch Co. Ltd.
21st Floor, 625 King's Road
North Point, Hong Kong
Customer Service Hotline: +852 2101 0235
Fax: +852 2590 9762
E-Mail: info@hk.bosch.com
www.bosch-pt.com.hk

India

Bosch Service Center
69, Habibullah Road, (Next to PSBB School), T. Nagar
Chennai – 600077
Phone: (044) 64561816

Bosch Service Center Rishyamook
85A, Panchkuin Road
New Delhi – 110001
Phone: (011) 43166190

Bosch Service Center
79, Crystal Bldg., Dr. Annie Besant Road, Worli
Mumbai – 400018
Phone: (022) 39569936 / (022) 39569959 /
(022) 39569967 / (022) 24952071

Indonesia

PT Robert Bosch
Palma Tower 10th Floor
Jalan RA Kartini II-S Kaveling 6
Pondok Pinang, Kebayoran Lama
Jakarta Selatan 12310
Tel.: (21) 3005-5800
www.bosch-pt.co.id

Malaysia

Robert Bosch Sdn. Bhd. (220975-V) PT/SMY
No. 8A, Jalan 13/6
46200 Petaling Jaya
Selangor
Tel.: (03) 79663194
Toll-Free: 1800 880188
Fax: (03) 79583838
E-Mail: kiathoe.chong@my.bosch.com
www.bosch-pt.com.my

Pakistan

Robert Bosch Middle East FZE – Pakistan Liaison Office
2nd Floor Plaza # 10, CCA Block, DHA Phase 5
Lahore, 54810
Phone: +92(303)4444311
Email: Faisal.Khan@bosch.com

Philippines

Robert Bosch, Inc.
28th Floor Fort Legend Towers,
3rd Avenue corner 31st Street,
Fort Bonifacio, Global City,
1634 Taguig City
Tel.: (632) 8703871
Fax: (632) 8703870
www.bosch-pt.com.ph

Singapore

Powerwell Service Centre Ptd Ltd
Bosch Authorised Service Centre (Power Tools)
4012 Ang Mo Kio Ave 10, #01-02 TECHplace
Singapore 569628
Tel.: 6452 1770
Fax: 6452 1760
E-Mail: ask@powerwellsc.com
www.powerwellsc.com
www.bosch-pt.com.sg

Thailand

Robert Bosch Ltd.
Liberty Square Building
No. 287, 11 Floor
Silom Road, Bangrak
Bangkok 10500
Tel.: 02 6393111
Fax: 02 2384783
Robert Bosch Ltd., P. O. Box 2054
Bangkok 10501
www.bosch.co.th

Bosch Service – Training Centre
La Salle Tower Ground Floor Unit No.2
10/11 La Salle Moo 16
Srinakharin Road
Bangkaew, Bang Plee
Samutprakarn 10540
Tel.: 02 7587555
Fax: 02 7587525

Vietnam

Branch of Bosch Vietnam Co., Ltd in HCMC
 Floor 10, 194 Golden Building
 473 Dien Bien Phu Street
 Ward 25, Binh Thanh District, Ho Chi Minh City
 Tel.: (08) 6258 3690
 Fax: (08) 6258 3692
 Hotline: (08) 6250 8555
 www.bosch-pt.com.vn

Armenia, Azerbaijan, Georgia, Kyrgyzstan, Mongolia, Tajikistan, Turkmenistan, Uzbekistan

TOO "Robert Bosch" Power Tools, After Sales Service
 Rayimbek Ave., 169/1
 050050, Almaty, Kazakhstan
 Service Email: service.pt.ka@bosch.com
 Official Website: www.bosch.com, www.bosch-pt.com

Bahrain

Hatem Al Juffali Technical Equipment Establishment.
 Kingdom of Bahrain, Setra Highway, Al Aker Area
 Phone: +966126971777-311
 Fax: +97317704257
 Email: h.berjas@ejjb.com.sa

Egypt

Unimar
 20 Markaz kadmat
 El tagmoa EL Aoul – New Cairo
 Phone: +20 2224 76091-95
 Phone: +20 2224 78072-73
 Fax: +20 2224 78075
 Email: adelzaki@unimaregypt.com

Iran

Robert Bosch Iran
 3rd Floor, No 3, Maadiran Building
 Aftab St., Khodami St., Vanak Sq.
 Tehran 1994834571
 Phone: +9821- 86092057

Iraq

Sahba Technology Group
 Al Muthana airport road
 Baghdad
 Phone: +9647901906953
 Phone Dubai: +97143973851
 Email: bosch@sahbatechnology.com

Jordan

Roots Arabia – Jordan
 Nasser Bin Jameel street, Building 37 Al Rabiah
 11194 Amman
 Phone: +962 6 5545778
 Email: bosch@rootsjordan.com

Kuwait

Al Qurain Automotive Trading Company
 Shuwaikh Industrial Area, Block 1, Plot 16, Street 3rd
 P.O. Box 164 – Safat 13002
 Phone: 24810844
 Fax: 24810879
 E-mail: josephkr@aaalmutawa.com

Lebanon

Tehini Hana & Co. S.A.R.L.
 P.O. Box 90-449
 Jdeideh
 Dora-Beirut
 Phone: +9611255211
 Email: service-pt@tehini-hana.com

Libya

El Naser for Workshop Tools
 Swanee Road, Alfalah Area
 Tripoli
 Phone: +218 21 4811184

Oman

Malatan Trading & Contracting LLC
 P.O. Box 131
 Ruwi, 112 Sultanate of Oman
 Phone: +968 99886794
 Email: malatanpowertools@malatan.net

Qatar

International Construction Solutions W L L
 P. O. Box 51, Doha
 Phone: +974 40065458
 Fax: +974 4453 8585
 Email: csd@icsdoha.com

Saudi Arabia

Juffali Technical Equipment Co. (JTECO)
 Kilo 14, Madinah Road, Al Bawadi District
 Jeddah 21431
 Phone: +966 2 6672222 Ext. 1528
 Fax: +966 2 6676308
 Email: roland@ejjb.com.sa

Syria

Dallal Establishment for Power Tools
 P.O. Box 1030
 Aleppo
 Phone: +963212116083
 Email: rita.dallal@hotmail.com

United Arab Emirates

Central Motors & Equipment LLC, P.O. Box 1984
 Al-Wahda Street – Old Sana Building
 Sharjah
 Phone: +971 6 593 2777
 Fax: +971 6 533 2269
 Email: powertools@centralmotors.ae

12 | English

Yemen

Abualrejal Trading Corporation
Sana'a Zubiery St. Front to new Parliament Building
Phone: +967-1-202010
Fax: +967-1-279029
Email: tech-tools@abualrejal.com

Ethiopia

Forever plc
Kebele 2,754, BP 4806,
Addis Ababa
Phone: +251 111 560 600
Email: foreverplc@ethionet.et

Ghana

C.WOERMANN LTD.
Nsawam Road/Avenor Junction, P.O. Box 1779
Accra
Phone: +233 302 225 141

Kenya

Robert Bosch East Africa Ltd
Mpaka Road P.O. Box 856
00606 Nairobi

Nigeria

Robert Bosch Nigeria Ltd.
52 – 54 Isaac John Street P.O. Box
GRA Ikeja – Lagos

Republic of South Africa

Customer service
Hotline: (011) 6519600

Gauteng – BSC Service Centre

35 Roper Street, New Centre
Johannesburg
Tel.: (011) 4939375
Fax: (011) 4930126
E-Mail: bsctools@icon.co.za

KZN – BSC Service Centre

Unit E, Almar Centre
143 Crompton Street
Pinetown
Tel.: (031) 7012120
Fax: (031) 7012446
E-Mail: bsc.dur@za.bosch.com

Western Cape – BSC Service Centre

Democracy Way, Prosperity Park
Milnerton
Tel.: (021) 5512577
Fax: (021) 5513223
E-Mail: bsc@zsd.co.za

Bosch Headquarters

Midrand, Gauteng
Tel.: (011) 6519600
Fax: (011) 6519880
E-Mail: rbsa-hq.pts@za.bosch.com

Tanzania

Diesel & Autoelectric Service Ltd.
117 Nyerere Rd., P.O. Box 70839
Vingunguti 12109, Dar Es Salaam
Phone: +255 222 861 793/794

Australia, New Zealand and Pacific Islands

Robert Bosch Australia Pty. Ltd.

Power Tools
Locked Bag 66
Clayton South VIC 3169
Customer Contact Center
Inside Australia:
Phone: (01300) 307044
Fax: (01300) 307045

Inside New Zealand:
Phone: (0800) 543353
Fax: (0800) 428570

Outside AU and NZ:
Phone: +61 3 95415555
www.bosch-pt.com.au
www.bosch-pt.co.nz

Environmental Protection

Chemicals dangerous to the environment must not be allowed to enter the ground, ground water or ponds, streams, etc.

For the use of cleaning agents, observe the instructions on the package and the prescribed concentration exactly.

For the cleaning of motor vehicles the local regulations should be observed: Do not allow oil sprayed off to enter into the ground water. Recycle raw materials instead of waste disposal.

Disposal

The pressure washer, accessories and packaging should be sorted for environmental-friendly recycling.

 Do not dispose of pressure washers into household waste!

Only for EC countries:

According to the European directive 2012/19/EU for Waste Electrical and Electronic Equipment and its implementation into national law, electrical and electronic equipment that are no longer usable must be collected separately and disposed of in an environmentally correct manner.

Subject to change without notice.

中文

安全规章

图标说明



一般性警告。



不可以把喷射出的水流朝向人、动物、机器或电动零件。

注意：如果使用不当，高压水柱可能造成危险。



根据适用的法规，如果机器不具备系统分离功能，便不可以连接到饮用水的供应系统上。根据 IEC 61770，得使用 BA 型的系统分离器。

流过系统分离器的水，已经不再是饮用水。

如果自行抽吸的话，要使用 3 米长的抽吸套件 (F 016 800 335)。

高压清洁机的安全规章



阅读所有的警告提示和指示。如未确实遵循警告提示和指示，可能导致电

击，火灾并且 / 或其他的严重伤害。

机器上的警告和提示牌提供了重要的讯息，能够确保操作安全。

除了遵循使用说明书上的指示之外，还必须兼顾一般性的安全规章和意外防范规定。

用电须知

- ▶ 电源的电压必须和机器铭牌上提供的电压一致。

- ▶ 最好将机器插在配备了 30 mA 剩于电流保护开关的插座上。
- ▶ 绝缘等级 I 的机器只能连接在按照规定且正确接地的电源上。
- ▶ 即使您只是暂时离开机器，也要从插座上拔出插头。
- ▶ 电源的电压必须符合 IEC 60364-1 的要求。
- ▶ 如果需要更换电线，得由机器的制造商、经过制造商授权的客服中心或合格的专业人员执行此工作，以避免危害安全。
- ▶ 不可以使用潮湿的手拿电线。
- ▶ 操作机器时不要拉扯插头。
- ▶ 不可以辗过、压过电线或延长线，也不可以拉扯它们。这样会损坏电线。电线必须远离高温、油垢和锋利的边缘。
- ▶ 如果电线或重要的零件，例如高压软管、喷射枪或安全装备等损坏了，便不可以使用机器。
- ▶ 注意：不符合规定的延长线可能造成危险。
- ▶ 使用延长线时，它的插头和连接装备都必须是防水的。延长线横截面的尺寸必须符合使用说明书上的规定，延长线也要具备防水花的功能。插头不可以浸泡在水中。
- ▶ 更换电线或延长线的插头时，不可以破坏电线或延长线的防水安全性能和稳定性。

14 | 中文

用水须知

- ▶ 请注意贵国供水单位的规定。
- ▶ 所有水管的接头都不可以漏水。
- ▶ 把机器连接在饮用水源上时，务必在机器上安装逆流阀。通过逆流阀的水则不适合饮用。
- ▶ 高压软管不能受损（有爆裂的危险）。高压软管如果损坏了必须马上更换。只能使用制造商推荐的水管和连接件。
- ▶ 高压软管，节流装备和连接装备都攸关机器的安全性能。只能使用机器制造厂商推荐的软管，节流装备和连接装备。
- ▶ 水源接头只能连接干净或经过过滤的水。

使用须知

- ▶ 正式操作之前，先检查机器和附件是否一切正常，是否会危害操作安全。如果发现任何故障则不可以使用机器。
- ▶ 不可以使用水流清洗自己的或别人的衣服、鞋子。
- ▶ 不可以吸汲含有溶解剂的液体、未稀释的酸性液体、丙酮或溶解剂，例如汽油、颜料稀释剂或柴油等。因为它们的喷雾极度易燃，容易爆炸并且有毒。
- ▶ 在危险的场所（例如加油站）使用本机器，务必遵守有关的安全规定。不可以有爆炸危险的场所使用本机器。
- ▶ 机器必须放在平稳的地面上。

- ▶ 在密闭的空间使用本机器时要确保通风良好。并确定清洁过程中车辆处于熄火状态（已经关闭马达）。
- ▶ 必须用双手操控高压清洁机。不可以在梯子上使用本机器。当在阳台或其他凸起的表面工作时，要确保随时能看到所有的场地边缘。
- ▶ 只能使用机器制造商推荐的清洁剂。并确实遵循机器制造商提出的使用说明、废弃处理建议和警告提示。
- ▶ 做好工作场所中所有会导电零件的防水措施。
- ▶ 操作机器时，不可以让喷射枪上的启动开关，卡牢在 "ON" 的位置。
- ▶ 穿着能够防水花的合适防护衣，如果在水流的喷射范围内有旁人则不可以使用机器，除非他穿著了防护衣。
- ▶ 必要时得穿上合适的防护装备（PSA）来防范喷溅的水花，例如佩戴护目镜，防尘面具等来避开从物体上反弹的水，颗粒和 / 或气溶胶。
- ▶ 使用高压清洁机时可能产生气溶胶。吸入气溶胶会危害健康。
- ▶ 高压可能造成物体回弹。必要时，得穿上合适的个人防护装备，例如护目镜。
- ▶ 为了避免高压水流造成伤害，清洁汽车轮胎和阀门时至少要保持 30 公分的距离。如果轮胎受损

了，首先会出现轮胎变色的情形。受损的轮胎 / 阀门都可能造成生命危险。

- ▶ 不可以喷洗含石棉和其它含有毒素的物体。
- ▶ 经推荐的清洁剂必须先稀释了再使用。这些产品是安全，因为它们不含酸、碱或 其它有害环境的物质。我们建议您把清洁剂，存放在儿童无法取得之处。清洁剂如果接触眼睛，必须马上用水彻底清洗。误食清洁剂必须马上就医。
- ▶ 使用高压清洁机时务必安装滤网，勿使用肮脏的或已经损坏的滤网。如果使用高压清洁机时未安装滤网，或是用了肮脏的、已经损坏的滤网，将导致保修失效。
- ▶ 长时间使用后，金属零件可能变烫。如果必要的话得戴上防护手套。
- ▶ 不要在恶劣的天气条件下特别是在雷雨来临时，操作高压清洁机。

操作须知

- ▶ 操作者务必按照规定使用机器。并且要注意操作现场的实际状况。工作时务必顾虑到旁人，尤其是儿童。
- ▶ 只有经过操作指导的人或可以证明能够操作本机器的人，才可以使用它。儿童或青少年不可以使用本机器。

- ▶ 不允许儿童，生理、感官或经神能力受限的人，经验不够和 / 或知识不足和 / 或不熟悉本指示的人操作本庭园工具。您本国的法规可能也会限制使用者的年龄。
- ▶ 看顾好小孩，以确保他们不会玩弄本庭园工具。
- ▶ 开动机器后，绝对不可以弃机器于不顾。
- ▶ 透过高压喷射出的水柱可能造成危险。因此要用双手握牢喷射枪和枪体。

搬运须知

- ▶ 搬运之前必须先关闭机器并固定好机器。

维修

- ▶ 清洁，维修机器和更换附件之前，都要先关闭机器。如果机器连接在插座上则要拔出插头。
- ▶ 维修的工作只能交给博世授权的维修工厂执行。

附件和备件

- ▶ 只能使用制造厂商规定的附件和备件。使用原厂的附件和原厂的备件才能够确保机器的正常功能。

代表符号

以下的符号可以帮助您正确地使用本机器。请详细阅读各符号及它们的代表意思。正确了解各符号所代表的意义，可以帮助您更有把握更安全地操作本机器。

16 | 中文

符号	含义
	移动方向
	重量
	开启
	关闭
Lo	较低的压力
Hi	较高的压力
	附件

按照规定使用机器

使用符合规定的附件（例如博世指定的清洁剂），便可以利用本机器清洁户外的空地和放在户外的物体。也可以使用本机器清洁机械设备、车辆和船。

合适的操作环境温度位在摄氏 0 度和 40 度之间。

技术数据

高压清洗机		GHP 8-15 XD	
物品代码		3 600 J10 3 . .	
额定输入功率		kW	4
进口温度最大		° C	50
进口水流最小		公升 / 每分	12,6
额定压力		MPa	15
最大工作压力		MPa	16
流量		公升 / 每分	12,6
最大进口压力		MPa	1
最大压力下枪身的反冲力		零线	33,24
马达绝缘		等级 F	
马达的防护种类		IPX5	
洗涤剂罐		I	
自动关机功能		●	
电力网电阻		-	
声压水平		分贝	85,5
不确定系数		分贝	3
声功率水平		分贝	93
不确定系数		分贝	3
振动总值		米 / 秒 ²	4,91
不确定系数		米 / 秒 ²	1,5

本说明书提供的参数是以 230 V 为依据，于低电压地区，此数据有可能不同。

开动电动工具时，电压会突然下降。如果电源网络状况不佳，可能会干扰其它机器。在电源阻抗小于 0,153 欧姆时不会产生干扰。

高压清洗机		GHP 8-15 XD	
重量符合 EPTA-Procedure 01:2014		公斤	40,6
绝缘等级			⊕ / I
序列号码		参考序列号码（型号铭牌） 在高压清洗机上	

本说明书提供的参数是以 230 V 为依据，于低电压地区，此数据有可能不同。

开动电动工具时，电压会突然下降。如果电源网络状况不佳，可能会干扰其它机器。在电源阻抗小于 0,153 欧姆时不会产生干扰。

安装和操作

执行目的	图片	页数
供货范围	1	59
安装手柄	2	60
安装吸尘管	3	61
安装通风喷嘴	4	62
填充洗涤剂箱	5	62
连接水源	6	63
清洁滤网	7	63
连接高压软管 / 喷射枪	8	64
调整压力	9	64
调整喷嘴的水柱	10	65
开动 / 关闭	11	65
清洁喷嘴	12	65

操作

针对您的安全



注意！从事任何保养或清洁的工作之前，要先关闭庭园工具，并拔出电源插头。如果电源线损坏了，被割损或纠结住了，也要采取以上措施。

基于安全的理由，本庭园工具备双重绝缘，无需接地。工作电压为 230 伏 AC，50 赫兹（针对非欧盟国家也有 220 伏或 240 伏）。

为了确保工作安全，必须使用最多 30 mA 额定剩余电流的漏电断路器 (RCD)。每次使用前都得检查该漏电断路器。

电源线和延长线必须定期检查，确认是否有损坏的迹象，上述电线只有在完好的状况下使用。

如果必须更换连接线，务必把这项工作交给博世或者经授权的博世电动工具顾客服务执行，以避免危害机器的安全性能。

只能使用经过核准的延长线。



小心：使用了不合格的延长线可能发生危险。只能使用能够防水，适合户外使用的延长线、插头和联结装置。

只有使用符合 EN61242 / IEC61242 或 IEC60884-2-7 等标准的延长线、电线或电线卷筒。

如果使用延长线操作本机器，必须采用以下的电线横截面：

- 电线截面 1,5 毫米² 针对最长达 20 米的延长线

电线的连接件（插头和插座）应保持干燥，而且不可以放在地上。

我们建议您，此时最好使用电线卷筒，它的插座距离地面至少要有 60 毫米以上。

指示：如果得使用延长线，该延长线必须有接地安全引线（如同安全规章上的规定）。该安全引线可以透过插头和您的电动设备的安全引线联结。

遵循延长线或电线卷筒制造商提供的操作指示，并参照各国有关使用上述物件的规定。

如有任何疑问可以向合格的电工或博世的服务人员询问。

针对不在英国出售的产品：

注意：为了您的安全，庭园工具上的插头必须连接在延长线上。延长线的插座必须能够防范喷溅的水花，并且是由橡胶制成或者覆盖着橡胶套。延长线上必须有防拉扯装备。

从敞开的容器中吸水

- 把装了过滤器的吸管（特殊的吸管套件，物品编号 F 016 800 335）安装在水源接头上。
- 将机器调整在低压状态并开动机器。
- 让机器运行约 10 秒钟，然后再关闭机器。多次重复上述过程，至出口的水流速度均匀而且水中没有气泡为止。

请注意，本机器不可以无水的情况下运转。

正式操作

开动

把水管（不包含在供货范围中）连接在水管接头和机器上。

确定电源开关是设定在“0”的位置并且把机器连接在插座上。

打开水龍頭。

启动制动开关后才能够扣扳机。把扳机扣到底至水流均匀并且机器和高压软管中没有空气为止。放开扳机。

将喷射枪朝下。启动制动开关以便解除扳机的锁定。把扳机按到底。

按下起 / 停开关。

自动关机功能

只要喷射枪手柄上的扳机被放开了，机器就会关闭马达。

有关操作方式的指点

一般通则

确定高压清洗机是放置在平坦的地面上。

不可以提着高压软管走得太前面，或者说不可以使用软管来拉动高压清洗机。这样可能导致高压清洗机摇晃并且翻倒。

不可以弯折高压软管，也不可以让车辆碾压高压软管。保护高压软管免被锋利的边缘或尖锐的凸角割损。

旋转喷嘴不可以用来洗车。

不可以在安全阀上进行任何不被允许的改变或调整。

油表尺

本高压清洗机配备了一个针对储存时使用的机油加注口盖，以及一个有通气孔（针对油表尺）的机油加注口盖，这个盖子是操作机器时使用的。

有关使用清洁剂时的操作指示

► 只能使用经过推荐并且适合高压清洗机的清洁剂。

基于环保的理念，必须节约使用清洁剂。请注意清洁剂容器上所标示的有关稀释清洁剂的建议说明。

使用博世提供的清洁剂和防腐剂才能确保机器无故障地运行。

建议的清洁方法

步骤 1：溶解污垢。

有节制地喷洒清洁剂，并让它在污垢上停留一段时间。

步骤 2：去除污垢。

使用高压冲除被溶解的污垢。

指示：清洁竖立的平面时，先以清洁剂由下往上清洗。接着再从上端朝下冲洗。

寻找故障的原因

症状	可能的原因	补救方法
马达无法起动	未插上插头	插好插头
	插头故障了	使用完好的插头
	保修丝断了	更换保险丝
	延长线故障了	拿掉延长线再试一次
	马达防护功能被启动了	让马达冷却约 15 分钟
	结冰了	让泵、水管及配件解冻
马达停止转动	保修丝断了	更换保险丝
	电压不符	检查电压，电压必须和机器铭牌上的规定一致
	马达防护功能被启动了	让马达冷却约 15 分钟
保险丝断了	保险丝太弱	把机器连接在别的电源系统，该系统的保险丝必须能够承担 高压清洁机的功率
马达继续运转，但是没有压力	喷嘴有一部分被堵塞了	清洁喷嘴
马达发出声音但是不运作	电压不足	检查电源的电压是否和机器铭牌上的规定一致
	因为使用延长线导致电压太低	检查所使用的延长线是否是合适的
	长期未使用机器	请向授权的博世顾客服务处求助
	自动停止功能出现问题	请向授权的博世顾客服务处求助
压力不均匀	水管中或泵中有空气	打开喷射枪和水龙头，将喷嘴调整到低压位置并让高压清洁机不断运转至恢复到均匀的工作压力为止
	水源供应不正常	检查水管的规格是否符合技术数据上的要求。允许使用的最小水管是 1/2 英寸或直径 13 毫米的水管
	滤网堵塞了	清洁滤网
	水管被压住或弯折了	摆好水管
	高压软管太长	拆下高压软管 - 延长件，最大的水管长度是 7 米
	喷嘴磨损了	更换喷嘴
指示：特定的配件会造成低压	起 / 停阀磨损了	连续 5 次快速地按下板机
马达在运转，但是压力受限，或是无操作压力	未连接水源	连接好水源
	滤网阻塞了	清洁滤网
	喷嘴阻塞了	清洁喷嘴
高压清洁机自动起动	泵或喷射枪不紧密	请向授权的博世顾客服务处求助
机器漏水	泵不紧密	微量漏水是可容许的，如果漏水量加大得接洽顾客服务中心
	把喷嘴调整在高压	喷嘴调整在 "Lo" 位置
无法吸清洁剂	清洁剂太粘稠	用水稀释
	高压软管被加长了	连接原厂软管
	清洁剂的循环管道中有残留物或管道变窄了	使用干净的水冲洗以便打通管道。如果问题仍然无法解决，得向博世的客服中心寻求建议

维修和服务

维修

▶ 在机器上进行任何维护、修理的工作之前必须先拔出插头和连接水管。

指示： 定期执行以下的维修工作，以延长机器的使用寿命和确保操作安全。

定期检查机器是否有明显的故障，例如松脱的固定零件和磨损的机件等。

检查盖子和防护罩是否完好，安装方式是否正确。必要时得在使用机器前执行维护或修理的工作。

搬运

移动高压清洁机时先握住机器上部的手柄，然后再透过滚动的轮子将它移动到需要的位置。

要越过阶梯或障碍物时，得握住高压清洁机上方的手柄，并将它提过阶梯或障碍物。

使用完毕后 / 收藏

使用软刷和布清洁高压清洁机的外壳。切勿使用水、稀释剂和抛光剂清洁机器。去除所有的污垢，尤其得清洁马达的通气缝隙。

季末储存机器时：放出泵中所有的水，此时要让马达运行数秒并扣动扳机。

不可以把其它的物品放置在机器上。

要确定储存时电线不会被夹住。勿折弯高压软管。

顾客服务处和顾客咨询中心

www.bosch-do-it.com

查询和购买备件时，务必提供机器铭牌上标示的 10 位数物品代码。

有关保证，维修或更换零件事宜，请向合格的经销商查询。

中国大陆

博世电动工具（中国）有限公司

中国 浙江省 杭州市

滨江区滨康路 567 号

邮政编码：310052

免费服务热线：4008268484

传真：(0571) 87774502

电邮：contact.ptcn@cn.bosch.com

www.bosch-pt.com.cn

罗伯特·博世有限公司

香港北角英皇道 625 号 21 楼

客户服务热线：+852 2101 0235

传真：+852 2590 9762

电邮：info@hk.bosch.com

网站：www.bosch-pt.com.hk

制造商地址：

Robert Bosch Power Tools GmbH

罗伯特·博世电动工具有限公司

70538 Stuttgart / GERMANY

70538 斯图加特 / 德国

环保须知

不可以让有害生态环境的化学物品残留在地面、地下水、池塘和河流中。

使用清洁剂时，务必详阅包装上的使用说明，以及注意规定的使用浓度。

清洗车辆时，必须兼顾贵国的有关法规：避免让冲刷下来的油垢流入地下水中。

处理废弃物

必须以符合环保要求的方式回收再利用高压清洁机、配件和包装材料。



不可以将高压清洁机丢入一般的家庭垃圾中！

只针对欧盟国家：

根据针对废旧电器和电子设备的欧洲法规 2012/19/EU 以及被纳入国家法律来执行的相关规定：必须分开收集损坏的电气和电子用品，并以符合环保要求的方式回收再利用。

保留修改权。

中文

安全規章

圖標說明



一般性警告。



不可以把喷射出的水流朝向人、动物、机器或电动零件。

注意： 如果使用不当，高压水柱可能造成危险。



根據適用的法規，如果機器不具備系統分離功能，便不可以連接到飲用水的供應系

統上。根據 IEC 61770，得使用 BA 型的系統分離器。

流過系統分離器的水，已經不再是飲用水。

如果自行抽吸的話，要使用 3 米長的抽吸套件 (F 016 800 335)。

高壓清潔機的安全規章



閱讀所有的警告提示和指示。 如未確實遵循警告提示和指示，可能導致電

擊、火災並且 / 或其他的嚴重傷害。

機器上的警告和提示牌提供了重要的訊息，能夠確保操作安全。

除了遵循使用說明書上的指示之外，還必須兼顧一般性的安全規章和意外防範規定。

用電須知

- ▶ 電源的電壓必須和機器銘牌上提供的電壓一致。
- ▶ 最好將機器插在配備了 30 mA 剩餘電流保護開關的插座上。
- ▶ 絕緣等級 I 的機器只能連接在按照規定且正確接地的電源上。
- ▶ 即使您只是暫時離開機器，也要從插座上拔出插頭。
- ▶ 電源的電壓必須符合 IEC 60364-1 的要求。
- ▶ 如果需要更換電線，得由機器的製造商、經過製造商授權的客服中心或合格的專業人員執行此工作，以避免危害安全。
- ▶ 不可以使用潮濕的手拿插頭。

- ▶ 操作機器時不要拉扯插頭。
- ▶ 不可以輾過、壓過電線或延長線，也不可以拉扯它們。這樣會損壞電線。電線必須遠離高溫、油垢和鋒利的邊緣。
- ▶ 如果電線或重要的零件，例如高壓軟管、噴射槍或安全裝備等損壞了，便不可以使用機器。
- ▶ 注意：不符合規定的延長線可能造成危險。
- ▶ 使用延長線時，它的插頭和連接裝備都必須是防水的。延長線橫截面的尺寸必須符合使用說明書上的規定，延長線也要具備防水花的功能。插頭不可以浸泡在水中。
- ▶ 更換電線或延長線的插頭時，不可以破壞電線或延長線的防水安全性能和穩定性。

用水須知

- ▶ 請注意貴國供水單位的規定。
- ▶ 所有水管的接頭都不可以漏水。
- ▶ 把機器連接在飲用水源上時，務必在機器上安裝逆流閥。通過逆流閥的水則不適合飲用。
- ▶ 高壓軟管不能受損（有爆裂的危險）。高壓軟管如果損壞了必須馬上更換。只能使用製造商推薦的水管和連接件。
- ▶ 高壓軟管，節流裝備和連接裝備都攸關機器的安全性能。只能使用機器製造廠商推薦的軟管，節流裝備和連接裝備。

- ▶ 水源接頭只能連接乾淨或經過過濾的水。

使用須知

- ▶ 正式操作之前，先檢查機器和附件是否一切正常，是否會危害操作安全。如果發現任何故障則不可以使用機器。
 - ▶ 不可以使用水流清洗自己的或別人的衣服、鞋子。
 - ▶ 不可以吸汲含有溶解劑的液體、未稀釋的酸性液體、丙酮或溶解劑，例如汽油、顏料稀釋劑或柴油等。因為它們的噴霧極度易燃，容易爆炸並且有毒。
 - ▶ 在危險的場所（例如加油站）使用本機器，務必遵守有關的安全規定。不可以有爆炸危險的場所使用本機器。
 - ▶ 機器必須放在平穩的地面上。
 - ▶ 在密閉的空間使用本機器時要確保通風良好。並確定清潔過程中車輛處於熄火狀態（已經關閉馬達）。
 - ▶ 必須用雙手操控高壓清潔機。不可以梯子上使用本機器。當在陽台或其他凸起的表面工作時，要確保隨時能看到所有的場地邊緣。
 - ▶ 只能使用機器製造商推薦的清潔劑。並確實遵循機器製造商提出的使用說明、廢棄處理建議和警告提示。
 - ▶ 做好工作場所中所有會導電零件的防水措施。
- ▶ 操作機器時，不可以讓噴射槍上的啟動開關，卡牢在 "ON" 的位置。
 - ▶ 穿著能夠防水花的合適防護衣，如果在水流的噴射範圍內有旁人則不可以使用機器，除非他穿著了防護衣。
 - ▶ 必要時得穿上合適的防護裝備（PSA）來防範噴濺的水花，例如佩戴護目鏡，防塵面具等來避開從物體上反彈的水，顆粒和 / 或氣溶膠。
 - ▶ 使用高壓清潔機時可能產生氣溶膠。吸入氣溶膠會危害健康。
 - ▶ 高壓可能造成物體回彈。必要時，得穿上合適的個人防護裝備，例如護目鏡。
 - ▶ 為了避免高壓水流造成傷害，清潔汽車輪胎和閥門時至少要保持 30 公分的距離。如果輪胎受損了，首先會出現輪胎變色的情形。受損的輪胎 / 閥門都可能造成生命危險。
 - ▶ 不可以噴洗含石棉和其它含有毒素的物體。
 - ▶ 經推薦的清潔劑必須先稀釋了再使用。這些產品是安全，因為它們不含酸、鹼或 其它有害環境的物質。我們建議您把清潔劑，存放在兒童無法取得之處。清潔劑如果接觸眼睛，必須馬上用水徹底清洗。誤食清潔劑必須馬上就醫。
 - ▶ 使用高壓清潔機時務必安裝濾網，勿使用肮髒的或已經損壞的

22 | 中文

濾網。 如果使用高壓清潔機時未安裝濾網，或是用了骯髒的、已經損壞的濾網，將導致保修失效。

- ▶ 長時間使用後，金屬零件可能變燙。如果必要的話得戴上防護手套。
- ▶ 不要在惡劣的天氣條件下特別是在雷雨來臨時，操作高壓清潔機。

操作須知

- ▶ 操作者務必按照規定使用機器。並且要注意操作現場的實際狀況。工作時務必顧慮到旁人，尤其是兒童。
- ▶ 只有經過操作指導的人或可以證明能夠操作本機器的人，才可以使用它。兒童或青少年不可以使用本機器。
- ▶ 不允許兒童，生理、感官或經神能力受限的人，經驗不夠和 / 或知識不足和 / 或不熟悉本指示的人操作本庭園工具。您本國的法規可能也會限制使用者的年齡。
- ▶ 看顧好小孩，以確保他們不會玩弄本庭園工具。
- ▶ 開動機器後，絕對不可以棄機器於不顧。
- ▶ 透過高壓噴射出的水柱可能造成危險。因此要用雙手握牢噴射槍和槍體。

搬運

- ▶ 搬運之前必須先關閉機器並固定好機器。

維修

- ▶ 清潔，維修機器和更換附件之前，都要先關閉機器。如果機器連接在插座上則要拔出插頭。
- ▶ 維修的工作只能交給博世授權的維修工廠執行。

附件和備件

- ▶ 只能使用製造廠商規定的附件和備件。使用原廠的附件和原廠的備件才能夠確保機器的正常功能。

代表符號

以下的符號可以幫助您正確地使用本機器。請詳細閱讀各符號及它們的代表意思。正確了解各符號所代表的意義，可以幫助您更有把握更安全地操作本機器。

符號	含義
	移動方向
	重量
	開啟
	關閉
Lo	較低的壓力
Hi	較高的壓力
	附件

按照規定使用機器

使用符合規定的附件（例如博世指定的清潔劑），便可以利用本機器清潔戶外的空地和放在戶外的物體。也可以使用本機器清潔機械設備、車輛和船。

合適的操作環境溫度位在攝氏 0 ° C 和 40 ° C 之間。

技術性數據

高壓清潔機		GHP 8-15 XD	
物品代碼		3 600 J10 3..	
額定輸入功率	kW		4
進口溫度最大	°C		50
進口水流最小	公升 / 每分		12,6
額定壓力	MPa		15
最大工作壓力	MPa		16
流量	公升 / 每分		12,6
最大進口壓力	MPa		1
最大壓力下槍身的反衝力	零線		33,24
馬達絕緣			等級 F
馬達的防護種類			IPX5
洗滌劑罐			I
自動關機功能			●
電力網電阻			-
聲壓水平	分貝		85,5
不確定系數	分貝		3
聲功率水平	分貝		93
不確定系數	分貝		3
振動總值	m/s ²		4,91
不確定系數	m/s ²		1,5
重量符合 EPTA-Procedure 01:2014	公斤		40,6
絕緣等級			⊕ / I
序列號碼	參考序列號碼 (型號銘牌) 在高壓清潔機上		

本說明書提供的參數是以 230 伏特為依據，於低電壓地區，此數據有可能不同。

開動電動工具時，電壓會突然下降。如果電源網絡狀況不佳，可能會干擾其它機器。在電源阻抗小於 0.153 歐姆時不會產生干擾。

安裝和操作

執行目的	圖片	頁數
供貨範圍	1	59
安裝手柄	2	60
安裝吸塵管	3	61
安裝通風噴嘴	4	62
填充洗滌劑箱	5	62
連接水源	6	63
清潔濾網	7	63
連接高壓軟管 / 噴射槍	8	64
調整壓力	9	64
調整噴嘴的水柱	10	65
開動 / 關閉	11	65
清潔噴嘴	12	65

操作

針對您的安全



注意！ 從事任何保養或清潔的工作之前，要先關閉庭園工具，並拔出電源插頭。如果電源線損壞了，被割損或糾結住了，也要採取以上措施。

基於安全的理由，本庭園工具備雙重絕緣，無需接地。工作電壓為 230 伏 AC，50 赫茲（針對非歐盟國家也有 220 伏或 240 伏）。

為了確保工作安全，必須使用最多 30 mA 額定剩餘電流的漏電斷路器 (RCD)。每次使用前都得檢查該漏電斷路器。

電源線和延長線必須定期檢查，確認是否有損壞的跡象，上述電線只有在完好的狀況下使用。

如果必須更換連接線，務必把這項工作交給博世或者經授權的博世電動工具顧客服務執行，以避免危害機器的安全性能。

只能使用經過核准的延長線。



小心：使用了不合格的延長線可能發生危險。只能使用能夠防水，適合戶外使用的延長線、插頭和聯結裝置。

只有使用符合 EN61242 / IEC61242 或 IEC60884-2-7 等標準的延長線，電線或電線卷筒。

如果使用延長線操作本機器，必須採用以下的電線橫截面：

- 電線截面 1,5 毫米² 針對最長達 20 米的延長線

電線的連接件（插頭和插座）應保持干燥，而且不可以放在地上。

我們建議您，此時最好使用電線卷筒，它的插座距離地面至少要有 60 毫米以上。

指示：如果得使用延長線，該延長線必須有接地安全引線（如同安全規章上的規定）。該安全引線可以透過插頭和您的電動設備的安全引線聯結。

遵循延長線或電線卷筒制造商提供的操作指示，並參照各國有關使用上述物件的規定。

如有任何疑問可以向合格的電工或博世的服務人員詢問。

針對不在英國出售的產品：

注意：為了您的安全，庭園工具上的插頭必須連接在延長線上。延長線的插座必須能夠防範噴濺的水花，並且是由橡膠制成或者覆蓋著橡膠套。延長線上必須有防拉扯裝備。

從敞開的容器中吸水

- 把裝了過濾器的吸管（特殊的吸管套件，物品編號 F 016 800 335）安裝在水源接頭上。
- 將機器調整在低壓狀態並開動機器。

24 | 中文

- 讓機器運行約 10 秒鐘，然後再關閉機器。多次重覆上述過程，至出口的水流速度均勻而且水中沒有氣泡為止。

請注意，本機器不可以在無水的情況下運轉。

正式操作

開動

把水管（不包含在供貨範圍中）連接在水管接頭和機器上。

確定電源開關是設定在 "0" 的位置並且把機器連接在插座上。

打開水龍頭。

啟動制動開關 後才能夠扣扳機。把扳機 扣到底至水流均勻並且機器和高壓軟管中沒有空氣為止。放開扳機。

將噴射槍 朝下。啟動制動開關 以便解除扳機 的鎖定。把扳機 按到底。

按下起 / 停開關。

自動關機功能

只要噴射槍手柄上的扳機被放開了，機器就會關閉馬達。

有關操作方式的指點

一般通則

確定高壓清潔機是放置在平坦的地面上。

尋找故障的原因

症狀	可能的原因	補救方法
馬達無法起動	未插上插頭	插好插頭
	插座故障了	使用其它的插座
	保險絲斷了	更換保險絲
	延長線故障了	拿掉延長線再試一次
	馬達防護功能被啟動了	讓馬達冷卻約 15 分鐘
馬達停止轉動	結冰了	讓泵、水管或配件解凍
	保險絲斷了	更換保險絲
保險絲斷了	電壓不符	檢查電壓，電壓必須和機器銘牌上的規定一致
	馬達防護功能被啟動了	讓馬達冷卻約 15 分鐘
保險絲斷了	保險絲太弱	把機器連接在別的電源系統，該系統的保險絲必須能夠承擔 高壓清潔機的功率
馬達繼續運轉，但是沒有壓力	噴嘴有一部分被堵塞了	清潔噴嘴

不可以提著高壓軟管走得太前面，或者說不可以使用軟管來拉動高壓清潔機。這樣可能導致高壓清潔機搖晃並且翻倒。

不可以彎折高壓軟管，也不可以讓車輛壓輾高壓軟管。保護高壓軟管免被鋒利的邊緣或尖銳的凸角割損。

旋轉噴嘴不可以用來洗車。

不可以在安全閘上進行任何不被允許的改變或調整。

油表尺

本高壓清潔機配備了一個針對儲存時使用的機油加注口蓋，以及一個有通氣孔（針對油表尺）的機油加注口蓋，這個蓋子是操作機器時使用的。

有關使用清潔劑時的操作指示

▶ 只能使用經過推薦並且適合高壓清潔機的清潔劑。

基於環保的理念，必須節約使用清潔劑。請注意清潔劑容器上所標示的有關稀釋清潔劑的建議說明。

使用博世提供的清潔劑和防腐劑才能確保機器無故障地運行。

建議的清潔方法

步驟 1：溶解污垢。

有節制地噴灑清潔劑，並讓它在污垢上停留一段時間。

步驟 2：去除污垢。

使用高壓沖除被溶解的污垢。

指示： 清潔豎立的平面時，先以清潔劑由下往上清洗。接著再從上端朝下沖洗。

症狀	可能的原因	補救方法
馬達發出聲音但是不運作	電壓不足	檢查電源的電壓是否和機器銘牌上的規定一致
	因為使用延長線導致電壓太低	檢查所使用的延長線是否是合適的
	長期未使用機器	請向授權的博世顧客服務處求助
壓力不均勻	自動停止功能出現問題	請向授權的博世顧客服務處求助
	水管中或泵中有空氣	打開噴射槍和水龍頭，將噴嘴調整到低壓位置並讓高壓清潔機不斷運轉至恢復到均勻的工作壓力為止
	水源供應不正常	檢查水管的規格是否符合技術數據上的要求。允許使用的最小水管是 1/2 英寸或直徑 13 毫米的水管
	濾網堵塞了	清潔濾網
	水管被壓住或彎折了	擺好水管
壓力均勻但是太弱	高壓軟管太長	拆下高壓軟管 - 延長件，最大的水管長度是 7 米
	噴嘴磨損了	更換噴嘴
	起 / 停閥磨損了	連續 5 次快速地按下板機
指示：特定的配件會造成低壓		
馬達在運轉，但是壓力受限，或是無操作壓力	未連接水源	連接好水源
	濾網阻塞了	清潔濾網
	噴嘴阻塞了	清潔噴嘴
高壓清潔機自動起動	泵或噴射槍不緊密	請向授權的博世顧客服務處求助
機器漏水	泵不緊密	微量漏水是可容許的，如果漏水量加大得接洽顧客服務中心
無法吸清潔劑	把噴嘴調整在高壓	噴嘴調整在 "Lo" 位置
	清潔劑太粘稠	用水稀釋
	高壓軟管被加長了	連接原廠軟管
	清潔劑的循環管道中有殘留物或管道變窄了	使用乾淨的水沖洗以便打通管道。如果問題仍然無法解決，得向博世的客服中心尋求建議

維修和服務

維修

- ▶ 在機器上進行任何維護、修理的工作之前必須先拔出插頭和連接水管。

指示： 定期執行以下的維修工作，以延長機器的使用壽命和確保操作安全。

定期檢查機器是否有明顯的故障，例如鬆脫的固定零件和磨損的機件等。

檢查蓋子和防護罩是否完好，安裝方式是否正確。必要時得在使用機器前執行維護或修理的工作。

搬運

移動高壓清潔機時先握住機器上部的手柄，然後再透過滾動的輪子將它移動到需要的位置。

要越過階梯或障礙物時，得握住高壓清潔機上方的手柄，並將它提過階梯或障礙物。

使用完畢後 / 收藏

使用軟刷和布清潔高壓清潔機的外殼。切勿使用水、稀釋劑和拋光劑清潔機器。去除所有的污垢，尤其得清潔馬達的通氣縫隙。

季末儲存機器時：放出泵中所有的水，此時要讓馬達運行數秒並扣動扳機。

不可以把其它的物品放置在機器上。

要確定儲存時電線不會被夾住。勿折彎高壓軟管。

顧客服務處和顧客諮詢中心

www.bosch-do-it.com

查詢和購買備件時，務必提供機器銘牌上標示的 10 位數物品代碼。

26 | 한국어

台灣

台灣羅伯特博世股份有限公司
 建國北路一段 90 號 6 樓
 台北市 10491
 電話：(02) 2515 5388
 傳真：(02) 2516 1176
 www.bosch-pt.com.tw

製造商地址：

Robert Bosch Power Tools GmbH
 羅伯特·博世電動工具有限公司
 70538 Stuttgart / GERMANY
 70538 斯圖加特 / 德國

環保須知

不可以讓有害生態環境的化學物品殘留在地面、地下水、池塘和河流中。
 使用清潔劑時，務必詳閱包裝上的使用說明，以及注意規定的使用濃度。
 清洗車輛時，必須兼顧貴國的有關法規：避免讓沖刷下來的油垢流入地下水中。

處理廢棄物

必須以符合環保要求的方式回收再利用高壓清潔機、配件和包裝材料。

 不可以將高壓清潔機丟入一般的家庭垃圾中!

只針對歐盟國家：

根據針對廢舊電器和電子設備的歐洲法規 2012/19/EU 以及被納入國家法律來執行的相關規定；必須分開收集壞損的電氣和電子用品，並以符合環保要求的方式回收再利用。

保留修改權。

한국어

안전 수칙

기호 설명

 일반적인 위험 경고.

 사람이나 동물 혹은 기기 본체 및 전기 부품에 물을 분사하지 마십시오.

주의: 고압 분사를 잘못 사용하면 위험할 수 있습니다.

 해당 규정에 따르면 시스템 분리기가 없는 기기를 식수 망에 연결해서는 안됩니다.

IEC 61770 Typ BA 에 따라 시스템 분리기를 사용하십시오.

시스템 분리기를 통과한 물을 식수로 사용해서는 안됩니다.

스스로 물을 흡입하는 자흡 기능의 경우 3 m 길이의 흡입 세트 (F 016 800 335) 가 필요합니다.

고압 세척기용 안전수칙

 모든 안전수칙과 지시 사항을 상세히 읽고 지켜야 합니다. 다음의 안전수칙과 지시 사항을 준수하지 않으면 화재 위험이 있으며 감전 혹은 중상을 입을 수 있습니다.

기기에 붙어있는 경고 및 지시 사항은 안전한 작동을 위한 중요한 내용입니다.

사용 설명서에 나와 있는 내용 이외에도 일반 안전규정과 사고방지 조치를 준수해야 합니다.

전원에 연결하기

- ▶전원의 전압이 기기 명판에 표기된 전압과 일치해야 합니다.
- ▶기기를 30 mA 누전 차단기가 있는 전원 콘센트에만 연결하는 것이 좋습니다.
- ▶안전 등급 I이므로 반드시 규정에 맞게 접지된 전원에 연결해야 합니다.

- ▶ 잠시라도 기기를 두고 자리를 비울 경우 전원 콘센트에서 플러그를 빼십시오.
- ▶ 전원 공급은 IEC 60364-1에 부응해야 합니다.
- ▶ 연결 코드를 교체해야 할 경우 안전사고를 방지하기 위해 제조사나 제조사가 지정한 서비스 센터 혹은 이를 실행할 수 있는 전문 기사에게 맡기십시오.
- ▶ 절대로 전원 플러그를 젖은 손으로 만지지 마십시오.
- ▶ 기기로 작업하는 도중에 전원 플러그를 당기지 마십시오.
- ▶ 전원 코드나 연장 케이블이 손상될 수 있으므로 차량에 밟이지 않도록 하고 조이거나 잡아당기지 마십시오. 케이블을 고열에 두지 말고 오일 혹은 날카로운 모서리에 접하지 않도록 하십시오.
- ▶ 전원 코드나 고압 호스, 분사 건, 안전장치 등 주요 부품이 손상된 경우 기기를 사용하지 마십시오.
- ▶ 주의: 규정에 맞지 않는 연장 케이블은 위험할 수 있습니다.
- ▶ 연장 케이블을 사용할 경우 플러그와 연결장치는 방수제품이어야 합니다. 연장 케이블의 직경은 사용 설명서에 나온 크기로 분사하는 물에 안전해야 합니다. 플러그 연결 부위가 물에 들어가지 않도록 하십시오.
- ▶ 전원 연결 코드나 연장 케이블의 플러그를 교환할 경우 물 분사에 안전하고 기계적인 안전성을 유지해야 합니다.

급수전에 연결하기

- ▶ 귀하의 급수 회사 규정을 준수하십시오.
- ▶ 모든 연결 호스의 연결장치가 밀폐되어 있어야 합니다.
- ▶ 절대로 기기를 역류 밸브 없이 식수 공급원에 연결해서는 안 됩니다. 역류 밸브를 통과한 물은 식수로 사용할 수 없다고 간주됩니다.
- ▶ 고압 호스가 손상되서는 안됩니다 (파열 위험). 손상된 고압 호스는 즉시 교환해 주십시오. 제조사가 추천하는 호스와 연결장치만을 사용해야 합니다.
- ▶ 고압 호스, 부속품 그리고 연결장치는 기기의 안전을 위해 중요합니다. 그러므로 제조사가 추천하는 호스와 부속품 및 연결장치만을 사용하십시오.
- ▶ 급수 연결장치에는 깨끗하거나 여과된 물만을 사용해야 합니다.

사용

- ▶ 사용하기 전에 기기와 액세서리가 정상 상태인지 안전한 작동 여부를 점검하십시오. 하자가 있으면 기기를 사용하면 안됩니다.
- ▶ 옷이나 신발을 세척하기 위해 작업자 자신이나 다른 사람에게 분사하지 마십시오.
- ▶ 용제를 함유한 액체, 희석되지 않은 산, 아세톤 혹은 벤진, 페인트 희석제, 난방유를 포함한 용제를 흡입해서는 안됩니다. 그 분무가 가연성이고 폭발성이며 독성이기 때문입니다.

28 | 한국어

- ▶ 주유소 등 위험한 분야에서 기기를 사용할 경우 이에 해당하는 안전수칙을 준수하십시오. 폭발 위험이 있는 곳에서는 사용이 금지되어 있습니다.
- ▶ 기기를 견고한 바닥 위에 놓아야 합니다.
- ▶ 밀폐된 공간에서 작업할 경우 충분히 환기해 주어야 합니다. 차량을 세척하는 동안 모터가 꺼져 있는지 확인해 보십시오.
- ▶ 고압 세척기는 양손으로 사용해야 합니다. 사다리 위에서 작업하지 마십시오. 발코니나 기타 높은 표면에 작업할 때 모든 모서리가 보이는지 확인하십시오.
- ▶ 반드시 기기 제조사가 추천하는 세제를 사용하고, 제조사의 사용 방법, 처리 및 경고 사항을 준수하십시오.
- ▶ 작업장에 있는 전류가 통하는 모든 부품은 물 분사에 안전해야 합니다.
- ▶ 작동할 때 분사 건 레버를 “ON” 위치로 고정해서는 안 됩니다.
- ▶ 물분사로부터 보호하기 위해 적합한 안전 복장을 하십시오. 안전 복장을 착용하지 않은 사람이 가까이 있으면 기기를 사용하지 마십시오.
- ▶ 사물에 반사되는 물이나 분자 혹은 에어로졸로부터 보호하기 위해 필요에 따라 보안경이나 분진 마스크 등 적합한 개인 보호구 (PPE) 를 착용하십시오.
- ▶ **고압 세척기를 사용할 때 에어로졸이 형성될 수 있습니다** 에어로졸을 들이 마시면 건강에 유해합니다.
- ▶ 높은 수압으로 인해 물체가 튕겨 나갈 수 있으므로 필요에 따라 보안경 등 적합한 보호 장비를 착용하십시오.
- ▶ 고압 분사로 인해 손상되는 것을 방지하기 위해 차량 타이어 / 밸브는 최소한 30 cm 간격을 유지하며 청소하십시오. 손상된 초기 증상은 타이어가 변색하는 것입니다. 손상된 차량 타이어 / 밸브는 매우 위험합니다.
- ▶ 석면을 함유하거나 유해한 물질을 함유한 소재를 분사해서는 안 됩니다.
- ▶ 추천하는 세제는 희석하여 사용해야 합니다. 제품에 산과 알칼리 혹은 환경에 유해한 물질이 함유되어 있지 않으므로 비교적 안전합니다. 세제는 어린이 손이 닿지 않는 곳에 보관하는 것이 좋습니다. 세제가 눈에 들어간 경우 즉시 물로 깨끗이 닦아내고, 삼켰을 경우 즉시 의사를 방문하십시오.
- ▶ **고압 세척기는 항상 필터를 장착하여 사용하고, 오염되거나 손상된 필터는 사용하지 마십시오.** 필터 없이 혹은 오염되거나 손상된 필터와 함께 고압 세척기를 사용한 경우 품질보장을 받지 못합니다.
- ▶ 장시간 사용하고 나면 금속 부품이 뜨거워질 수 있습니다. 필요에 따라 보호장갑을 착용하십시오.
- ▶ 날씨가 좋지 않은 경우 특히 번개 위험이 있으면 고압 세척기를 사용하지 마십시오.

작동

- ▶ 작업자는 기기를 규정에 따른 사용 분야에만 사용해야 합니다. 현지 상황을 고려하십시오. 작업 시 주위에 어린이나 사람이 있는지 주의하십시오.
- ▶ 본 기기는 사용법과 취급에 대한 교육을 받거나 기기를 작동할 수 있는 자격이 있는 사람만이 사용해야 합니다. 어린이나 청소년이 이 기기를 작동해서는 안 됩니다.
- ▶ 어린이나 신체적, 감각 기능 혹은 정신적 기능에 장애가 있는 사람, 혹은 경험과 지식이 부족하거나 사용법을 잘 모르는 사람이 절대로 이 기기를 사용하지 못하게 하십시오. 국내 규정에 따라 사용자 연령 제한이 있을 수 있습니다.
- ▶ 어린이가 정원용 공구를 갖고 놀지 않도록 감독하십시오.
- ▶ 기기의 스위치가 켜진 상태에서 절대로 자리를 비우면 안 됩니다.
- ▶ 고압 노즐에서 나오는 물분사로 반동이 생기므로 분사 건과 분사 램스를 양손으로 꼭 잡으십시오.

운반

- ▶ 운반하기 전에 기기의 스위치를 끄고 안전하게 하십시오.

보수 정비

- ▶ 각종 세척 및 보수작업을 하거나 액세서리를 교환하기 전에 반드시 기기의 스위치를 끄십시오. 기기를 배전 전압에 연결하여 작동할 경우 전원 플러그를 빼십시오.





- ▶ 수리는 반드시 보쉬 지정 서비스 센터에서만 실시하도록 맡기십시오.

액세서리와 스페어 부품

- ▶ 제조사가 허용하는 액세서리와 부품만을 사용하십시오. 정품 액세서리 및 부품을 사용해야 하자 없는 기기의 작동을 보장할 수 있습니다.

기호

다음에 나와있는 기호는 사용 설명서를 읽고 이해하는 데 중요합니다. 그러므로 기호와 그 의미를 잘 기억하십시오. 기호를 제대로 이해하면 전동공구를 더욱 쉽고 안전하게 사용할 수 있습니다.

기호	의미
	이동 방향
	중량
	온
	오프
Lo	저압
Hi	고압
	별매 액세서리

규정에 따른 사용

본 기기는 실외에 있는 표면이나 물체에 물청소할 때, 보쉬사가 허용하는 세제 등 해당 액세서리를 사용하여 기기, 자동차, 보트를 세척할 때 사용해야 합니다.

규정에 따른 사용은 주변 온도 0 °C에서 40 °C 사이의 경우입니다.

30 | 한국어

제품 사양

고압 세척기		GHP 8-15 XD
제품 번호		3 600 J10 3..
정격 출력	kW	4
최대 급수 온도	°C	50
분당 급수량	l/min	12.6
정격 압력	MPa	15
최대 작동 압력	MPa	16
토출량	l/min	12.6
최대 급수 압력	MPa	1
최대 압력 시 랜스의 반동	N	33.24
모터 절연 등급		등급 F
모터 보호 등급		IPX5
세제 탱크		l
자동 정지 기능		●
전원 임피던스		-
음압 레벨	dB(A)	85.5
불확실성	dB(A)	3
음향 레벨	dB(A)	93
불확실성	dB(A)	3
총 진동치	m/s ²	4.91
불확실성	m/s ²	1.5
EPTA 공정 01:2014 에 따른		
중량	kg	40.6
안전 등급		⊕ / I
일련번호	고압 세척기에 있는 일련번호 (명판) 참조	

자료는 정격 전압 [U] 230 V 를 기준으로 한 것입니다. 전압이 낮거나 각국의 특수한 모델에 따라 달라질 수 있습니다.

돌입 전류는 단시간 전압 강하를 유발합니다. 전원 공급 조건이 좋지 않은 경우 다른 기기에 영향을 미칠 수 있습니다. 전원 공급 시스템 임피던스가 0.153 Ohm 이하인 경우 아무런 이상이 없습니다.

조립 및 작동

작업 내용	그림	페이지
공급 내역	1	59
손잡이 조립하기	2	60
호스 조립하기	3	61
통풍용 오일 막대 끼우기	4	62
세제 용기 충입하기	5	62
급수전에 연결하기	6	63
필터 청소하기	7	63
고압 호스 / 분사 건 연결	8	64
수압 조절하기	9	64
노즐 분사 조절하기	10	65
전원 스위치 작동하기	11	65
노즐 청소하기	12	65

시동

작업 안전



주의! 보수 정비 혹은 세척작업을 하기 전에 정원용 공구의 스위치를 끄고 전원 플러그를 빼십시오. 이는 전원 코드가 손상되거나 절단 혹은 영킨 경우에도 해당됩니다.

귀하의 정원용 공구는 안전상 절연되어 있으므로 접지가 필요하지 않습니다. 작동 전압은 230 V AC, 50 Hz (EU 이외의 국가에서는 220 V 혹은 240 V) 입니다.

안전을 기하기 위해 잔류 전류가 최대 30 mA 인 누전 차단기 (RCD) 를 사용하십시오. 사용하기 전에 매번 누전 차단기를 점검하십시오.

전선과 연장 케이블은 규칙적으로 손상부위가 있는지 점검하고 오직 완전한 상태에서만 사용되어야 합니다.

연결 코드를 교환해야 할 경우 안전을 기하기 위해 보쉬 사나 보쉬 지정 전동공구 서비스 센터에 맡겨야 합니다. 오직 허용된 연장 케이블만을 사용하십시오.



주의: 규정에 맞지 않는 연장 케이블은 위험할 수 있습니다. 연장 케이블, 플러그, 연결 장치는 방수제품으로 실외용 모델이어야 합니다.

연장 케이블이나 케이블 릴은 오직 EN 61242 / IEC 61242 또는 IEC 60884-2-7 규격에 해당된 것만을 사용하십시오.

만약 공구의 작동시 연장 케이블의 사용을 원할 경우, 다음과 같은 전선 단면적이 필요합니다.

- 길이 20 m 까지의 연장 케이블을 위한 전선 단면적은 1.5 mm² 입니다

전선의 연결부 (전선 플러그와 콘센트) 는 물기가 없어야 하며 바닥에 두지 마십시오.

이를 위해 콘센트가 지상에서 적어도 60 mm 위에 있는 케이블 릴을 사용하는 것이 좋습니다.

참고: 연장 케이블을 사용할 경우 안전 규정에 나온대로 접지되어 있어야 하며 귀하의 전기 설비 접지선이 플러그에 연결되어 있어야 합니다.

연장 케이블 혹은 케이블 릴 사용 시, 제조사의 사용 설명서와 각 해당 국가의 규정을 준수하십시오.

확실하지 않은 경우 전기 기사나 가까운 보쉬 서비스 센터에 문의하십시오.

영국 이외에서 판매되는 제품에 해당 사항:

주의: 귀하의 안전을 위해, 정원용 공구에 부착된 플러그는 연장 케이블을 연결하여 사용해야 합니다. 연장 케이블의 연결 부위는 튀기는 물에 안전해야 하며, 고무 재질이거나 고무로 피복되어 있어야 합니다. 연장 케이블은 변형 완화장치와 함께 사용해야 합니다.

열려 있는 급수 용기에서 물 흡입하기

- 필터가 있는 흡입 호스 (특수 흡입 호스 세트, 제품 번호 F 016 800 335) 를 급수 연결장치에 조입니다.
- 기기를 저압 모드로 맞추십시오.

- 마지막으로 기기를 약 10 초 동안 가동한 후에 기기의 스위치를 끄십시오. 급수 상태가 일정하고 거품이 나지 않을 때까지 이 과정을 반복하십시오.

본 제품은 반드시 물을 사용하여 작동해야 합니다.

작동

스위치 켜기

물호스 (별매품) 로 급수 연결장치와 기기를 연결하십시오.

전력 본선 스위치가 "0" 위치에 있는 상태에서 기기를 전원 콘센트에 연결해야 합니다.

수도꼭지를 엽니다.

방아쇠를 풀기 위해 시동차단 버튼을 누르십시오. 물이 일정하게 흐르고 기기와 고압 호스 안에 있는 공기가 완전히 빠질 때까지 방아쇠를 끝까지 누르십시오. 방아쇠를 놓으십시오.

분사 건을 아래로 향하게 하십시오. 방아쇠를 풀기 위해 시동차단 버튼을 누르십시오. 방아쇠를 끝까지 누르십시오.

전원 스위치를 작동하십시오.

자동 정지 기능

피스톤 손잡이의 방아쇠를 놓으면 기기가 자동으로 정지됩니다.

사용방법

일반

고압 세척기가 평평한 바닥에 놓여 있는지 확인하십시오.

고압 호스를 들고 너무 앞으로 가거나 호스를 잡고 고압 세척기를 당기지 마십시오. 이 경우 고압 세척기가 불안정하게 되어 쓰러질 수 있습니다.

고압 호스를 꺾지 말고 차량에 밝히지 않도록 하십시오. 고압 호스가 날카로운 모서리나 구석에 닿지 않도록 하십시오.

자동차를 세차할 때 회전 노즐을 사용하지 마십시오.

안전 밸브를 변형하거나 조정하지 마십시오.

오일 측정 막대

고압 세척기는 보관할 때 사용하는 오일 마개와 작동할 때 사용하는 통풍구가 있는 마개 (오일 측정 막대) 와 함께 공급됩니다.

세제 사용 시 사용방법

▶ 고압 세척기용으로 나온 세제만을 사용하십시오.

환경보호를 위해 소량의 세제를 사용하는 것이 좋습니다.

용기에 표기된 희석에 관한 추천 내용을 준수하십시오.

보시는 정선된 세제와 방부제를 제공하여 기기의 원활한 작동을 보장합니다.

추천하는 청소방법

1 단계 : 더러운 부위 분리

소량의 세제를 뿌려 잠시 작용하게 두십시오.

2 단계 : 더러운 부위 제거

강한 수압으로 분리된 더러운 부위를 제거하십시오.

주의 : 세제를 사용하여 수직면에 세척할 때 아래서부터 시작하여 위로 작업하십시오. 씻어낼 때는 위에서 아래로 작업하십시오.

고장 원인찾기

증상	가능한 원인	조치
모터가 가동하지 않습니다	전원 플러그가 연결되지 않았습니다	전원 플러그를 연결하십시오
	콘센트가 고장입니다	다른 콘센트를 사용하십시오
	퓨즈가 단선되었습니다	퓨즈를 교체하십시오
	연장 케이블이 손상되었습니다	연장 케이블 없이 시도하십시오
	모터 보호장치가 작동하였습니다	모터를 15 분 동안 식하십시오
	동결되었습니다	펌프, 호스 및 액세서리를 해동하십시오
모터가 정지됩니다	퓨즈가 단선되었습니다	퓨즈를 교체하십시오
	배전 전압이 맞지 않습니다	배전 전압이 기기 명판에 표기된 전압과 일치하는지 확인하십시오
	모터 보호장치가 작동하였습니다	모터를 15 분 동안 식하십시오
퓨즈가 단선됩니다	퓨즈가 너무 약합니다	고압 세척기의 성능에 맞게 안전장치가 되어 있는 전원에 연결하십시오
모터는 가동하지만 수압이 없습니다	노즐이 일부 막혔습니다	노즐 청소하기

32 한국어			
증상	가능한 원인	조치	
모터 소리는 나는데 작동하지 않습니다	배전 전압이 부족합니다	전원의 전압이 기기 명판에 표기된 전압과 일치하는지 확인하십시오	
	연장 케이블을 사용하여 전압이 너무 낮습니다	연장 케이블이 적합한지 확인해 보십시오	
	기기를 너무 오랫동안 사용하지 않았습니까	보쉬 지정 서비스 센터에 문의하십시오	
	자동정지 기능이 문제가 있습니까	보쉬 지정 서비스 센터에 문의하십시오	
수압이 맥동합니다	호스나 펌프에 공기가 들어 있습니다	일정한 작동 압력이 될 때까지 분사 건을 누르고 급수전을 연 채 저압 모드로 고압 세척기를 작동하십시오	
	급수 상태가 적합하지 않습니다	급수 연결이 제품 사양에 나와 있는 내용과 부응하는지 확인하십시오. 사용 가능한 최소한 호스 크기는 1/2" 혹은 직경 13 mm 입니다	
	필터가 막혔습니다	필터를 청소하십시오	
	호스가 눌렀거나 꺾인 상태입니다	호스를 일직선으로 놓으십시오	
	고압 호스가 너무 길다	고압 호스 연장선을 빼십시오, 최대 호스 길이 7 m	
	수압이 일정하지만 너무 낮습니다	노즐이 마모되었습니다	노즐을 교체하십시오
참고 : 특정한 액세서리로 인해 수압이 낮아집니다	시동 / 정지 밸브가 마모되었습니다	방아쇠를 짧은 간격으로 5 회 작동하십시오	
	모터는 작동하지만 수압이 한정되거나 작동 압력에 미달합니다	급수가 연결되지 않았습니다	급수를 연결하십시오
		필터가 막혔습니다	필터 청소하기
	노즐이 막혔습니다	노즐을 청소하십시오	
고압 세척기가 자동으로 시동합니다	펌프나 분사 건이 썩니다	보쉬 지정 서비스 센터에 문의하십시오	
	기기가 썩니다	펌프가 썩니다	약간의 누수는 무방합니다; 누수가 심하면 서비스 센터에 문의하십시오
세제가 흡입되지 않습니다	조절 가능한 노즐이 고압 위치에 있습니다	노즐을 "Lo" 상태로 놓으십시오	
	세제가 너무 끈적거립니다	물로 희석하십시오	
	고압 호스가 연장되었습니다	정품 호스를 연결하십시오	
	세제 순환장치에 잔여물이 있어 좁아졌습니다	깨끗한 물로 씻어내고 좁아진 것을 제거하십시오. 그래도 계속 문제가 있으면 보쉬 서비스 센터에 문의하십시오.	

보수 정비 및 서비스

보수 정비

- ▶ 기기에 각종 보수 정비작업을 하기 전에 전원 플러그를 빼고 급수 연결장치를 풀어 주십시오.

참고 : 장기간 신뢰성 있는 사용을 보장하기 위해 다음의 보수 정비작업을 정기적으로 실시하십시오.

기기의 조임장치가 느슨하거나 부품이 마모 혹은 손상되지 않았는지 정기적으로 점검하십시오.

커버와 안전장치가 손상되지 않았는지 제대로 부착되어 있는지 확인하십시오. 사용하기 전에 필요한 보수 및 수리작업을 실시하십시오.

운반

고압 세척기를 움직이려면 상단 손잡이를 잡고 굴러서 원하는 장소까지 이동하십시오.

고압 세척기를 계단이나 장애물 너머로 운반하려면 상단 손잡이를 잡고 들어 옮기십시오.

사용 후 관리 / 보관

고압 세척기 표면은 부드러운 솔이나 천으로 깨끗이 닦아 주십시오. 물, 용제 혹은 광택제를 사용하면 안됩니다. 더러운 부위를 모두 닦고, 특히 모터의 통풍구를 청소하십시오.

시즌 후 보관 : 모터를 몇 초간 작동하고 방아쇠를 당겨 펌프에서 물을 완전히 빼십시오.

기기 위에 아무런 물건도 올려놓지 마십시오.

보관 시 케이블이 조여져 있지 않은지 확인해 보십시오.
고압 호스가 꺾이지 않도록 하십시오.

보쉬 AS 및 고객 상담

www.bosch-do-it.com

문의 사항이 있거나 스페어 부품을 주문할 때 반드시 기
기의 명판에 표기된 10 자리의 제품 번호를 알려 주십시
오.

Bosch Korea, RBKR
Mechanics and Electronics Ltd.
PT/SAX-ASA
298 Bojeong-dong Giheung-gu
Yongin-si, Gyeonggi-do, 446-913
080-955-0909

환경 보호

환경에 유해한 화학물이 토지, 지하수, 연못이나 강으로
들어가는는 안 됩니다.

세제를 사용할 경우 포장에 나온 내용과 규정된 농도를
정확히 준수하십시오.

모터 차량을 세척할 경우 현재의 규정을 준수하십시오 :
분사한 오일이 지하수 안으로 들어가지 않도록 해야 합니
다.

처리

고압 세척기, 액세서리 및 포장 등은 환경 친화적인 방법
으로 재활용 수 있도록 분류하십시오.



고압 세척기를 가정용 쓰레기로 처리하지 마십시
오!

EU 국가만 해당 :

폐전자제품처리에 관한 EU 지침 2012/19/EU 와 해
당 국가법 이행에 따라 더 이상 사용이 불가능한 전기제
품과 전자제품은 분리 수거하여 환경 친화적인 방법으로
재활용하도록 해야 합니다.

위 사항은 사전 예고 없이 변경될 수도 있습니다.

ภาษาไทย

กฎระเบียบเพื่อความปลอดภัย

คำอธิบายของสัญลักษณ์



การเตือนอันตรายทั่วไป



อย่าเลี้ยงลำนํ้าที่ฉีดออกมา
พุ่งตรงไปยังคน ลัตว์ เครื่อง
หรือชิ้นส่วนไฟฟ้าอย่าง
เด็ดขาด

คำเตือน: ลำนํ้าฉีดแรงดันสูงอาจเป็น
อันตรายได้หากใช้ในทางที่ผิด



ตามระเบียบที่ใช้บังคับ

ต้องไม่เชื่อมต่อเครื่อง

เข้ากับเครือข่ายน้ำประปาดื่ม

โดยไม่มีอุปกรณ์แยกกระบบอย่างเด็ด
ขาด ใช้อุปกรณ์แยกกระบบตาม
มาตรฐานสากล IEC 61770
ประเภท BA

น้ำที่ไหลผ่านอุปกรณ์แยกกระบบ
ถือว่าดื่มไม่ได้

สำหรับปั๊มแบบล่อนํ้าด้วยตนเอง

ให้ใช้ชุดคู่มือพิเศษยาว 3 ม.

(F 016 800 335)

คำเตือนเพื่อความปลอดภัยสำหรับ
เครื่องฉีดน้ำแรงดันสูง



ต้องอ่านคำเตือนเพื่อความ

ปลอดภัยและคำสั่งทั้งหมด

การไม่ปฏิบัติตามคำเตือนและ

คำสั่งอาจเป็นสาเหตุให้ถูกไฟฟ้า

ดูด เกิดไฟไหม้ และ/หรือได้รับบาดเจ็บ

อย่างร้ายแรง

ป้ายเตือนและข้อมูลที่ติดมากับ

เครื่องให้ข้อมูลสำคัญเกี่ยวกับ

การทำงานอย่างปลอดภัย

34 | ภาษาไทย

นอกจากข้อมูลในหนังสือคู่มือการใช้งานแล้ว ยังต้องปฏิบัติตามคำเตือนเพื่อความปลอดภัยทั่วไป และกฎระเบียบเพื่อการป้องกันการเกิดอุบัติเหตุด้วย

การเชื่อมต่อกับแหล่งจ่ายกระแสไฟฟ้า

- ▶ แรงดันไฟฟ้าที่ระบุไว้บนแผ่นป้ายต้องสอดคล้องกับแรงดันไฟฟ้าของแหล่งจ่ายกระแสไฟฟ้า
- ▶ เราขอแนะนำให้เชื่อมต่อเครื่องนี้เข้ากับเต้าเสียบที่มีการป้องกันด้วยเครื่องตัดกระแสไฟฟ้าเศษเหลือขนาด 30 mA เท่านั้น
- ▶ ต้องเชื่อมต่อเครื่องที่มีระดับป้องกัน I เครื่องนี้เข้ากับแหล่งจ่ายกระแสไฟฟ้าที่มีการต่อลงดินอย่างถูกต้องเท่านั้น
- ▶ ถอดปลั๊กไฟออกจากเต้าเสียบเมื่อใดก็ตามที่ท่านปล่อยเครื่องไว้โดยไม่ดูแลแม้ช่วงเวลาสั้นๆ
- ▶ การเชื่อมต่อไฟฟ้าต้องสอดคล้องกับมาตรฐานสากล IEC 60364-1
- ▶ หากสายไฟฟ้าชำรุด ต้องส่งเครื่องไปเปลี่ยนสายไฟฟ้าที่บริษัทผู้ผลิต ศูนย์บริการของบริษัท หรือบุคคลที่มีคุณสมบัติใกล้เคียงกัน ทั้งนี้เพื่อหลีกเลี่ยงอันตราย
- ▶ อย่าสัมผัสปลั๊กไฟด้วยมือเปียกๆ อย่างเด็ดขาด
- ▶ อย่าดึงปลั๊กไฟในขณะที่กำลังใช้เครื่องทำงาน
- ▶ อย่าวิ่งทับ บีบอัด หรือดึงสายเคเบิลและสายไฟต่อพ่วง มิฉะนั้นอาจเสียหายได้ ปกป้องสายเคเบิลจากความร้อน น้ำมัน และขอบแหลมคม

- ▶ อย่าใช้เครื่องหากสายเคเบิลหรือชิ้นส่วนสำคัญ ต.ย. เช่น สายยางแรงดันสูง ปืนฉีด หรืออุปกรณ์ความปลอดภัยเสียหาย
- ▶ คำเตือน:
สายไฟต่อพ่วงที่ไม่ตรงตามกฎระเบียบอาจเป็นอันตรายได้
- ▶ หากใช้สายไฟต่อพ่วงทำงาน ปลั๊กไฟ และเต้าเสียบจะต้องออกแบบให้กันน้ำได้ สายไฟต่อพ่วงต้องมีภาคตัดขวางตามหนังสือคู่มือการใช้งานและได้รับการปกป้องจากน้ำที่สะอาดกระเด็น ต้องไม่วางการเชื่อมต่อในน้ำ
- ▶ เมื่อเปลี่ยนปลั๊กไฟที่สายเคเบิลหรือสายไฟต่อพ่วง การปกป้องน้ำสะอาดกระเด็นและความคงตัวของเครื่องมือกลจะต้องยังคงเหมือนเดิม

การเชื่อมต่อกับน้ำ

- ▶ ปฏิบัติตามระเบียบข้อบังคับของบริษัทจัดส่งน้ำของท่าน
- ▶ สายยางเชื่อมต่อทั้งหมดต้องมีข้อต่อสนิทกันรั่วอย่างถูกต้อง
- ▶ อย่าเชื่อมต่อเครื่องเข้ากับระบบจ่ายน้ำประปาดื่มโดยไม่มีวาล์วป้องกันน้ำไหลกลับอย่างเด็ดขาด น้ำที่ผ่านวาล์วป้องกันน้ำไหลกลับถือว่าดื่มไม่ได้อีกต่อไป
- ▶ สายยางแรงดันสูงต้องไม่เสียหาย (อันตรายจากการระเบิด) ต้องเปลี่ยนสายยางแรงดันสูงที่เสียหายทันที ใช้เฉพาะสายยางและอุปกรณ์เชื่อมต่อที่แนะนำโดยบริษัทผู้ผลิตเท่านั้น

- ▶ สายยางแรงดันสูง พัดตั้ง และข้อต่อเพลลา มีความสำคัญต่อความปลอดภัยของเครื่อง ใช้เฉพาะสายยาง พัดตั้ง และข้อต่อเพลลาที่แนะนำโดยบริษัทผู้ผลิตเท่านั้น
- ▶ นำเข้าเฉพาะน้ำที่กรองหรือน้ำสะอาดเท่านั้น

การใช้งาน

- ▶ ก่อนใช้งาน ให้ตรวจสอบเครื่องและอุปกรณ์ทำงานว่าอยู่ในสภาพที่สมบูรณ์แบบและมีความปลอดภัยในการทำงานหรือไม่ อย่าใช้งานหากเครื่องไม่อยู่ในสภาพดีสมบูรณ์แบบ
- ▶ อย่าเล็งลำน้ำที่ฉีดออกมาตรงไปยังตัวท่าน หรือคนอื่นๆ เพื่อทำความสะอาดเสื้อผ้า หรือรองเท้า
- ▶ อย่าสูบเข้าของเหลวที่มีตัวทำละลายกรดเข้มข้น อะซิโตน หรือตัวทำละลาย! ซึ่งรวมถึงน้ำมัน ทินเนอร์ สี น้ำมันให้ความร้อน ไอน้ำที่พุ่งออกมามีคุณสมบัติติดไฟสูง ระเบิดได้ และเป็นพิษ
- ▶ เมื่อใช้เครื่องในพื้นที่อันตราย (เช่น สถานีเติมน้ำมัน) ต้องปฏิบัติตามกฎระเบียบเพื่อความปลอดภัยที่เกี่ยวข้อง ห้ามใช้เครื่องทำงานในสถานที่ที่อาจระเบิดได้
- ▶ ต้องวางเครื่องบนฐานที่มั่นคง
- ▶ หากใช้เครื่องในสถานที่คับแคบ ต้องตรวจสอบให้แน่ใจว่ามีการระบายอากาศที่เพียงพอ ตรวจสอบให้แน่ใจว่าได้เปิดสวิตช์ยานยนต์ทั้งหมดตลอดเวลาที่ทำความสะอาด
- ▶ เมื่อใช้เครื่องนี้ทำงาน ต้องใช้มือทั้งสองข้างตลอดเวลา ยื่อนำเครื่องขึ้นไปใช้บนบันได เมื่อใช้เครื่องบนระเบียงหรือบริเวณยกพื้นอื่นๆ ท่านต้องมั่นใจว่าท่านสามารถมองเห็นขอบพื้นตลอดเวลา
- ▶ ใช้เฉพาะน้ำยาทำความสะอาดที่แนะนำโดยบริษัทผู้ผลิตเท่านั้น และปฏิบัติตามคำแนะนำการใช้งาน การกำจัด และค่าเตือนของบริษัทผู้ผลิต
- ▶ ส่วนประกอบที่นำไฟฟ้าทั้งหมดที่อยู่ในพื้นที่ทำงานต้องได้รับการป้องกันจากน้ำสาตกระเด็น
- ▶ ไกปืนฉีดต้องไม่ถูกหนีบอยู่ในตำแหน่ง "เปิด" ระหว่างทำงาน
- ▶ สวมชุดป้องกันที่เหมาะสมเพื่อกันน้ำสาตกระเด็น อย่าใช้เครื่องในบริเวณที่มีคน เว้นแต่คนเหล่านั้นจะสวมใส่ชุดป้องกันด้วยเช่นกัน
- ▶ สวมใส่อุปกรณ์ป้องกันอันตรายส่วนบุคคล (PPE) ต.ย. เช่น แวนครอบตานิรภัย อุปกรณ์ป้องกันการหายใจ เป็นต้น เพื่อป้องกันน้ำ อนุภาค และ/หรือละอองลอยที่ฉีดกลับมาจากชิ้นส่วน หากจำเป็น
- ▶ ระหว่างใช้งานเครื่องฉีดน้ำแรงดันสูงอาจเกิดละอองลอย การสูดดมละอองลอยอาจเป็นอันตรายต่อสุขภาพ
- ▶ แรงดันสูงอาจทำให้มีวัตถุกระเด็นกลับ หากจำเป็น ให้สวมอุปกรณ์ป้องกันตัวที่เหมาะสม เช่น แวนครอบตานิรภัย

36 | ภาษาไทย

- ▶ เพื่อหลีกเลี่ยงความเสียหายจากลำน้ำที่ฉีดออกมาด้วยแรงดันสูง ให้ทำความสะอาดล้อ/วาล์วของยานยนต์จากระยะห่างอย่างน้อย 30 ซม. ปราบกฎการณเบืองตันของความเสียหายคือล้อเปลี่ยนสี ล้อ/วาล์วของยานยนต์ที่เสียหายอาจเป็นอันตรายอย่างยิ่ง
- ▶ ต้องไม่พ่นวัสดุที่มีแร่ใยหินและวัสดุอื่นๆ ที่มีสารที่เป็นอันตรายต่อสุขภาพของท่านออกมา
- ▶ อย่าใช้น้ำยาทำความสะอาดโดยไม่เจือจาง ผลิตภัณฑ์ที่ใช้จะมีความปลอดภัยเมื่อไม่มีกรดผสม ไม่มีด่างหรือสารที่เป็นอันตรายต่อสภาพแวดล้อม เราขอแนะนำให้เก็บน้ำยาทำความสะอาดให้พ้นมือเด็ก ถ้าน้ำยาทำความสะอาดเข้าตา ให้ล้างด้วยน้ำปริมาณมากทันที และถ้ากลืนกินให้ปรึกษาแพทย์ทันที
- ▶ อย่าใช้เครื่องฉีดน้ำแรงดันสูงโดยไม่มีตัวกรอง หรือใช้ร่วมกับตัวกรองที่สกปรกหรือชำรุดอย่างเด็ดขาด การใช้เครื่องฉีดน้ำแรงดันสูงโดยไม่มีตัวกรอง หรือใช้ร่วมกับตัวกรองที่สกปรกหรือชำรุด อาจทำให้การรับประกันเป็นโมฆะ
- ▶ ชิ้นส่วนโลหะอาจร้อนขึ้นหลังใช้งานเป็นเวลานาน ให้สวมถุงมือป้องกันหากจำเป็น
- ▶ หลีกเลี่ยงการชำระล้างด้วยแรงดันสูงในสภาพอากาศที่เลวร้าย โดยเฉพาะอย่างยิ่งเมื่อมีความเสี่ยงต่อการเกิดฟ้าผ่า

การปฏิบัติงาน

- ▶ ผู้ใช้งานเครื่องต้องใช้เครื่องตามกฎระเบียบ เมื่อใช้เครื่องทำงาน ต้องตระหนักถึงสถานะเงื่อนไขที่กำหนดในท้องถิ่น มีสติใส่ใจบุคคลอื่น โดยเฉพาะอย่างยิ่งเด็กๆ
 - ▶ บุคคลที่สามารถใช้เครื่องนี้ได้ต้องได้รับการฝึกฝน หรือได้แสดงให้เห็นว่ามีความสามารถใช้งานเครื่องนี้ได้เท่านั้น ต้องไม่ให้เด็กหรือเยาวชนใช้งานเครื่องนี้ (อันตรายจากอุบัติเหตุเนื่องจากการใช้งานอย่างไม่ถูกวิธี)
 - ▶ อย่าให้เด็ก บุคคลที่มีความบกพร่องทางกายภาพ ทางประสาทสัมผัส หรือทางจิต หรือขาดประสบการณ์ และ/หรือความรู้ และ/หรือบุคคลที่ไม่คุ้นเคยกับคำแนะนำเหล่านี้ นำเครื่องมือทำสวนไปใช้งาน ช้อบบังคับของประเทศอาจจำกัดอายุของผู้ใช้งานเครื่อง
 - ▶ เด็กควรได้รับการดูแลเพื่อให้แน่ใจว่าพวกเขาจะไม่นำเครื่องมาเล่น
 - ▶ อย่าทิ้งเครื่องโดยไม่มีกรควบคุมดูแลในขณะที่เครื่องเปิดสวิทช์อยู่อย่างเด็ดขาด
 - ▶ ลำน้ำที่ฉีดออกมาจากหัวฉีดแรงดันสูงทำให้เกิดการถอยกลับที่ปั่นฉีด ท่านจึงควรถือปืนฉีดและก้านฉีดแบบพ่นละอองด้วยมือทั้งสองข้างอย่างแน่นหนา
- การขนย้าย**
- ▶ ปิดสวิทช์มอเตอร์และทำเครื่องให้กระชับ ก่อนขนย้าย

การบำรุงรักษา





- ▶ ปิดสวิตช์เครื่องก่อนทำความสะอาด และบำรุงรักษาทุกครั้ง และก่อนเปลี่ยนส่วนประกอบ ดึงปลั๊กไฟ ออกหากเครื่องทำงานด้วยไฟฟ้า
- ▶ ส่งเครื่องให้ศูนย์บริการ บို့ช ที่ได้รับมอบหมายซ่อมแซมเท่านั้น

อุปกรณ์ประกอบและอะไหล่

- ▶ ใช้เฉพาะอุปกรณ์ประกอบและอะไหล่ที่ผ่านการรับรองจาก บို့ช เท่านั้น อุปกรณ์ประกอบและอะไหล่ของแท้เท่านั้นที่รับประกันว่าเครื่องจะสามารถทำงานได้อย่างปลอดภัย และไม่ชำรุดเสียหาย

สัญลักษณ์

สัญลักษณ์ต่อไปนี้มีความสำคัญต่อการอ่านและการทำความเข้าใจคู่มือการใช้งานเครื่อง กรุณาจดจำสัญลักษณ์และความหมายของสัญลักษณ์ การแปลความสัญลักษณ์ได้ถูกต้องจะช่วยให้คุณใช้เครื่องได้ดีและปลอดภัยกว่า

สัญลักษณ์	ความหมาย
	ทิศทางการเคลื่อนที่
	น้ำหนักร
	เปิด
	ปิด
Lo	แรงดันต่ำ
Hi	แรงดันสูง
	อุปกรณ์ประกอบ

ประโยชน์การใช้งานของเครื่อง

เครื่องนี้ใช้สำหรับทำความสะอาดพื้นที่และวัตถุภายนอกบ้าน เครื่องมือ ยานยนต์ และเรือ หากใช้อุปกรณ์ประกอบที่เหมาะสม เช่น สารทำความสะอาดที่ผ่านการรับรองจาก บို့ช การใช้งานหมายถึงการทำงานที่มีอุณหภูมิโดยรอบระหว่าง 0 °C และ 40 °C

ข้อมูลทางเทคนิค

เครื่องฉีดน้ำแรงดันสูง		GHP 8-15 XD
หมายเลขสินค้า		3 600 J10 3..
กำลังไฟฟ้า	กิโวลต์	4
อุณหภูมิน้ำเข้า สูงสุด	°C	50
ประมาณน้ำเข้า น้อยสุด	ลิตร/วินาที	12.6
แรงดันกำหนด	MPa	15
แรงดันที่ใช้งานสูงสุด	MPa	16
อัตราน้ำที่ไหลผ่าน	ลิตร/วินาที	12.6
แรงดันด้านเข้าสูงสุด	MPa	1
แรงผลึกที่ปั่นฉีดที่แรงดันสูงสุด	N	33.24
การฉนวนมอเตอร์		ระดับชั้น F
การป้องกันมอเตอร์		IPX5
ถังบรรจุน้ำยาทำ		
ความปลอดภัย		I
ระบบหยุดทำงานอัตโนมัติ		●
ความต้านทานต่อไฟฟ้าสลับ		–
ระดับความดันเสียง	เดซิเบล (A)	85.5
ความคลาดเคลื่อน	เดซิเบล (A)	3
ระดับความดังเสียง	เดซิเบล (A)	93
ความคลาดเคลื่อน	เดซิเบล (A)	3
ค่าความลื่นสะเทือนรวม	m/s ²	4.91
ความคลาดเคลื่อน	m/s ²	1.5
น้ำหนักตามระเบียบการ-EPTA-Procedure 01:2014	กก.	40.6
ระดับความปลอดภัย		⊕ / I
หมายเลขเครื่อง	ดูหมายเลขเครื่อง (แผ่นป้าย) บนเครื่องฉีดน้ำแรงดันสูง	
ค่าที่ให้ใช้ได้กับแรงดันไฟฟ้าระบุ [U] 230 โวลท์ ค่าเหล่านี้อาจคิดแยกไปสำหรับแรงดันไฟฟ้าที่ต่ำกว่า และไม่เคลมที่สร้างสำหรับเฉพาะประเทศ		
กระบวนการสตาร์ทเครื่องจะทำให้แรงดันไฟฟ้าหย่อนลงลึกชั่วคราว ในกรณีที่มีสภาพระบบสายไฟหลักไม่เอื้ออำนวย อาจเกิดคลื่นรบกวนอุปกรณ์/เครื่องอื่นๆ ได้ คาดว่าจะไม่เกิดการดำเนินงานที่ผิดปกติเมื่อมีความต้านทานต่อไฟฟ้าสลับต่ำกว่า 0.153 โอห์ม		

38 | ภาษาไทย

การประกอบและการปฏิบัติงาน

ขั้นตอน	ภาพประกอบ	หน้า
รายการสิ่งของที่จัดส่ง	1	59
ประกอบตามจับ	2	60
การติดตั้งท่อ	3	61
การใส่ก้านวัดระดับน้ำมัน		
ระบายนม	4	62
เติมน้ำมันยาทำความสะอาด	5	62
การเชื่อมต่อกับน้ำ	6	63
การทำทำความสะอาดตัวกรองน้ำ	7	63
การเชื่อมต่อสายยางส่งน้ำ		
แรงดันสูง/หัวฉีด	8	64
การปรับแรงดันน้ำ	9	64
การปรับลำน้ำที่ฉีดออกมา	10	65
การเปิดและปิดสวิตช์	11	65
การทำทำความสะอาดหัวฉีด	12	65

การเริ่มต้นปฏิบัติงาน**เพื่อความปลอดภัยของท่าน**

คำเตือน! ปิดสวิตช์และถอดปลั๊กไฟฟ้าออกก่อน
ปรับแต่งเครื่อง ทำความสะอาด
หรือเมื่อสายเคเบิลถูก
ตัด เสียหาย หรือพันกันยุ่ง

เครื่องของท่านมีฉนวนสองชั้นเพื่อความปลอดภัย และ
ไม่จำเป็นต้องต่อสายดิน แรงดันไฟฟ้าใช้งาน คือ 230 V AC,
50 Hz (สำหรับประเทศนอกสหภาพยุโรป 220 V, 240 V
ตามแต่กรณี)

เพื่อเพิ่มความปลอดภัยทางไฟฟ้า ให้ใช้อุปกรณ์ป้องกัน
ไฟฟ้าดูด (RCD) ที่มีกระแสไฟฟ้าทริบไม่เกิน 30 mA
ตรวจสอบอุปกรณ์ RCD ทุกครั้งเมื่อใช้งาน

ต้องตรวจสอบสายเคเบิลและสายไฟต่อพ่วงเพื่อหาสัญญาณ
ความเสียหายเป็นประจำ และใช้งานได้เฉพาะเมื่ออยู่ใน
สภาพที่สมบูรณ์เท่านั้น

เมื่อจำเป็นต้องเปลี่ยนสายไฟฟ้า ให้ส่งเครื่องให้บริษัท
บ็อชหรือศูนย์บริการลูกค้าสำหรับเครื่องมือไฟฟ้า บ็อช ที่ได้รับ
มอบหมายทำการเปลี่ยนให้ เพื่อหลีกเลี่ยงอันตรายด้าน
ความปลอดภัย

ใช้เฉพาะสายไฟต่อพ่วงที่ได้รับอนุญาตเท่านั้น



คำเตือน: สายไฟต่อพ่วงที่ไม่ตรงตามกฎ
ระเบียบอาจเป็นอันตรายได้ สายไฟต่อพ่วง
ปลั๊กไฟฟ้า และเต้าเสียบจะต้องออกแบบให้
กันน้ำได้ และผลิตไว้สำหรับใช้ภายนอกอาคาร

ใช้เฉพาะสายเคเบิล สายไฟต่อพ่วง หรือล้อเก็บสายไฟที่
สอดคล้องกับมาตรฐาน EN 61242/IEC 61242 หรือ
IEC 60884-2-7

เมื่อใช้งานผลิตภัณฑ์ หากท่านต้องการใช้สายไฟต่อพ่วง
ต้องให้เฉพาะสายไฟฟ้าที่มีขนาดหน้าตัดดังต่อไปนี้:

- ตัวนำที่มีขนาดพื้นที่หน้าตัดระบุ 1.5 มม.² สำหรับชุด
สายไฟต่อพ่วงยาวสูงสุด 20 ม.

การเชื่อมต่อสายเคเบิล (ปลั๊กไฟฟ้าและเต้าเสียบ)
ต้องแห้งและไม่วางอยู่บนพื้นดิน

เพื่อจุดประสงค์นี้เราขอแนะนำให้ใช้ล้อเก็บสายไฟซึ่งมี
เต้าเสียบอยู่เหนือพื้นดินอย่างน้อย 60 มม.

หมายเหตุ: หากใช้สายไฟต่อพ่วง สายไฟต่อพ่วงต้องมีสายดิน
และเชื่อมต่อกับปลั๊กไฟฟ้าไปยังสายเคเบิลดินของระบบไฟฟ้า
ของท่าน ดังที่อธิบายไว้ในกฎระเบียบเพื่อความปลอดภัย

ปฏิบัติตามหนังสือคู่มือการใช้งานของบริษัทผู้ผลิตสายไฟ
ต่อพ่วงหรือล้อเก็บสายไฟ และกฎระเบียบท้องถิ่นเกี่ยวกับการ
ใช้งานอุปกรณ์เหล่านี้

หากมีข้อสงสัย ให้ปรึกษาช่างไฟฟ้าที่มีคุณสมบัติเหมาะสม
หรือศูนย์บริการ บ็อช ที่ใกล้เคียงที่สุด

**สำหรับผลิตภัณฑ์ที่ไม่ได้จำหน่ายในสหราชอาณาจักร
บริเตนใหญ่:**

คำเตือน: เพื่อความปลอดภัยของท่าน จำเป็นต้องเชื่อมต่อปลั๊ก
ไฟฟ้าที่ติดมากับเครื่องเข้ากับสายไฟต่อพ่วง การเชื่อมต่อของ
สายไฟต่อพ่วงจะต้องได้รับการปกป้องจากน้ำที่สะอาดกระเด็น
ซึ่งอาจทำจากยางหรือเคลือบด้วยยาง ต้องใช้สายไฟต่อพ่วง
กับตัวพ่นแรงดันสูงสายเคเบิล

การดูดน้ำออกจากภาชนะเปิด

- ชันสายยางดูดที่มีตัวกรอง (ชุดดูดพิเศษ หมายเลขชิ้นส่วน
F 016 800 335) เข้ากับการเชื่อมต่อหน้า
- เปิดสวิตช์เครื่องที่การตั้งแรงดันต่ำ
- ปลดปล่อยเครื่องทำงานประมาณ 10 วินาที จากนั้นจึง
ปิดสวิตช์ ทำซ้ำขั้นตอนนี้หลายครั้งจนกว่าจะมีน้ำไหล
อย่างสม่ำเสมอและไม่ฟองอากาศ

เพื่อป้องกันความเสียหายต่อเครื่อง อย่าปล่อยเครื่องทำงาน
โดยไม่มีน้ำ

การปฏิบัติงาน**การสตาร์ท**

เชื่อมต่อสายยางส่งน้ำ (ไม่ได้จัดส่งมาด้วย) เข้ากับท่อน้ำ
ประปาและเครื่อง

ตรวจสอบให้แน่ใจว่าสวิตช์ไฟฟ้าอยู่ในตำแหน่งปิด "0"
และเชื่อมต่อเครื่องเข้ากับเต้าเสียบ

เปิดก๊อกน้ำ

กดล้อคนิรภัย เพื่อปลดไก กดไก อย่างเต็มที่จนน้ำ
ไหลอย่างราบรื่นและไม่มียากอากาศในเครื่องและในสายยาง
ส่งน้ำอีกต่อไป ปลดปล่อยน้ำออกจากไก

เล็งปืนฉีด ลงด้านล่าง กดล้อคนิรภัย เพื่อปลดไก กดไก
อย่างเต็มที่

เปิดปิดสวิตช์

ระบบหยุดทำงานอัตโนมัติ

เครื่องนี้ถูกออกแบบให้มอเตอร์ปิดสวิตช์ในทันทีที่ท่านปล่อย
นิ้วออกจากไกบนด้ามปืนฉีด

ข้อแนะนำในการทำงาน

ทั่วไป

ตรวจสอบให้แน่ใจว่าเครื่องฉีดน้ำแรงดันสูงวางอยู่บนพื้นราบ

อย่าจับสายยางแรงดันสูงไปข้างหน้ามากเกินไป หรืออย่าเลื่อนเครื่องฉีดน้ำแรงดันสูงโดยดึงสายยาง การกระทำดังกล่าวอาจทำให้เครื่องวางอย่างไม่มั่นคงและล้มได้

อย่าดึงสายยางแรงดันสูงหรือเคลื่อนยานยนต์ที่ปลายยาง ปกป้องสายยางแรงดันสูงจากขอบหรือมุมที่แหลมคม

อย่าใช้หัวฉีดแบบหมุนสำหรับทำความสะอาดยานยนต์อย่างเด็ดขาด

อย่าเปลี่ยนแปลงหรือปรับการตั้งค่าว่าสวิตช์

ก้านวัดระดับน้ำมัน

เครื่องฉีดน้ำแรงดันสูงจัดส่งมาพร้อมฝาปิดน้ำมันสำหรับการจัดเก็บเครื่อง และฝาปิดที่มีรูระบายลม (ก้านวัดระดับน้ำมัน) สำหรับการใช้เครื่องทำงาน

ข้อแนะนำในการทำงานสำหรับการทำความสะอาดด้วยน้ำยา

▶ ใช้สารทำความสะอาดที่เหมาะสมที่ใช้เฉพาะสำหรับเครื่องฉีดน้ำแรงดันสูงเท่านั้น

เราขอแนะนำให้ท่านใช้น้ำยาทำความสะอาดเท่าที่จำเป็นเพื่อรักษาสภาพแวดล้อม ปฏิบัติตามสัดส่วนการเจือจางที่แนะนำบนฉลากสารทำความสะอาด

โดยการนำเสนอสารทำความสะอาดและถนอมรักษาเป็นรายประเภทแก่ท่าน บ็อช จึงรับประกันว่าเครื่องจะสามารถทำงานได้อย่างราบรื่น

วิธีทำความสะอาดที่แนะนำ

ขั้นตอนที่ 1: คลายสิ่งสกปรกออก

ฉีดพ่นสารทำความสะอาดเท่าที่จำเป็น และปล่อยให้แสดงปฏิกิริยาลึกชั่วครู่

ขั้นตอนที่ 2: เอาสิ่งสกปรกออก

ขจัดสิ่งสกปรกที่คลายออกโดยการฉีดพ่นแรงดันสูง

หมายเหตุ: เมื่อทำความสะอาดพื้นผิวในแนวตั้ง ให้ฉีดพ่นสิ่งสกปรก/น้ำยาทำความสะอาดจากด้านล่างและฉีดพ่นขึ้นด้านบน ชำระล้างออกจากด้านบนและฉีดพ่นลงด้านล่าง

การแก้ไขปัญหา

ปัญหา	สาเหตุที่เป็นไปได้	มาตรการแก้ไข
มอเตอร์ไม่สตาร์ท	ไม่ได้เสียบปลั๊กไฟฟ้า	เสียบปลั๊กไฟฟ้า
	เต้าเสียบไฟฟ้าบกพร่อง	ใช้เต้าเสียบอื่น
	ฟิวส์ขาด	เปลี่ยนฟิวส์ใหม่
	สายไฟต่อพ่วงเสียหาย	ลองโดยไม่ใช้สายไฟต่อพ่วง
	อุปกรณ์ป้องกันมอเตอร์ถูกเรียกใช้งาน	ปล่อยให้เย็นลงประมาณ 15 นาที
	เย็นแข็ง	รอให้หิมะ/สายยางส่งน้ำ/อุปกรณ์ประกอบละลาย
มอเตอร์หยุดทำงาน	ฟิวส์ขาด	เปลี่ยนฟิวส์ใหม่
	แรงดันไฟฟ้าไม่ถูกต้อง	ตรวจสอบแรงดันไฟฟ้า แรงดันไฟฟ้าต้องสอดคล้องกับข้อมูลจำเพาะบนแผ่นป้ายพิกัดรุ่น
ฟิวส์ขาด	อุปกรณ์ป้องกันมอเตอร์ถูกเรียกใช้งาน	ปล่อยให้เย็นลงประมาณ 15 นาที
	ขนาดของฟิวส์ไม่ถูกต้อง	เปลี่ยนที่วงจรไฟฟ้า ใส่ฟิวส์ที่มีขนาดสูงกว่าที่ตรงกับขนาดแอมป์ของเครื่องฉีดน้ำแรงดันสูง
มอเตอร์สตาร์ทแต่ไม่มีแรงดัน	หัวฉีดบางส่วนอุดตัน	การทำความสะอาดหัวฉีด
มอเตอร์ "มีเสียง" แต่ไม่สตาร์ท	การจ่ายไฟฟ้าไม่เพียงพอ	ตรวจสอบว่าแรงดันของสายไฟฟ้าจากแหล่งจ่ายกระแสไฟฟ้าตรงกับที่ระบุบนแผ่นป้ายพิกัดหรือไม่
	แรงดันไฟฟ้าต่ำเกินไปเนื่องจากใช้สายไฟต่อพ่วง	ตรวจสอบลักษณะเฉพาะของสายไฟต่อพ่วง
	ไม่ได้ใช้เครื่องเป็นเวลานาน	ติดต่อศูนย์บริการ บ็อช ของท่าน
	มีปัญหาที่ระบบหยุดทำงานอัตโนมัติ	ติดต่อศูนย์บริการ บ็อช ของท่าน

40 ภาษาไทย		
ปัญหา	สาเหตุที่เป็นไปได้	มาตรการแก้ไข
แรงดันเดินเป็นจังหวะ	อากาศในสายยางส่งน้ำ/ปั๊ม	ปล่อยเครื่องฉีดน้ำแรงดันสูงวิ่งโดยเปิดปืนฉีดและตั้งหัวฉีดที่แรงดันต่ำจนได้แรงดันทำงานที่สม่ำเสมอ
	การจ่ายน้ำไม่เพียงพอ	ตรวจสอบว่าการจ่ายน้ำสอดคล้องกับข้อมูลจำเพาะหรือไม่ สายยางส่งน้ำที่เล็กที่สุดที่สามารถใช้ได้คือ 1/2" หรือเส้นผ่าศูนย์กลาง 13 มม.
	ตัวกรองน้ำอุดตัน	ทำความสะอาดตัวกรองน้ำ
	สายยางส่งน้ำถูกบีบอัด	ทำสายยางส่งน้ำที่ขดงอให้ตรง
	สายยางแรงดันสูงยาวเกินไป	ถอดสายยางฟ่วงต่อแรงดันสององ ลองอีกครั้ง (สายยางฟ่วงต่อสูงสุด 7 ม.)
แรงดันสม่ำเสมอแต่ต่ำเกินไป	หัวฉีดเสื่อมสภาพ	เปลี่ยนหัวฉีดใหม่
หมายเหตุ: อุปกรณ์ประกอบบางตัวจะทำให้เกิดแรงดันต่ำ	วาล์วสตาร์ท/หยุด เสื่อมสภาพ	เหนียวไถ 5 ครั้งติดต่อกันอย่างรวดเร็ว
มอเตอร์ทำงานแต่มีแรงดันจำกัดหรือไม่มีแรงดันทำงาน	ไม่มีการจ่ายน้ำ	เชื่อมต่อการจ่ายน้ำ
	ตัวกรองน้ำอุดตัน	การทำความสะอาดตัวกรองน้ำ
	หัวฉีดอุดตัน	ทำความสะอาดหัวฉีด
เครื่องฉีดน้ำแรงดันสูงติดขึ้นเองอย่างผิดปกติ	ปั๊มปืนฉีดรั่ว	ติดต่อศูนย์บริการ บ็อกซ์ ของท่าน
	น้ำรั่วจากเครื่อง	ปั๊มรั่ว
ไม่มีน้ำยาทำความสะอาดดูดเข้ามา	ตั้งหัวฉีดปรับได้ที่แรงดันสูง	ตั้งหัวฉีดที่ "Lo"
	น้ำยาทำความสะอาดชนิดเกินไป	เจือจางด้วยน้ำ
	สายยางแรงดันสูงถูกต่อขยาย	ติดตั้งสายยางของแท้
	ลิ่งตักค้างหรือการตีบตันในวงจรมอเตอร์ทำความสะอาด	ล้างออกด้วยน้ำสะอาดและขจัด
	การตีบตันใดๆ หากยังมีปัญหาอยู่ ให้ติดต่อศูนย์บริการ บ็อกซ์ ของท่าน	

การบำรุงรักษาและบริการ

การบำรุงรักษา

- ▶ **หยุดเครื่อง ดึงปลั๊กไฟ** ออกจากเต้าเสียบ และปลดการเชื่อมต่อ

หมายเหตุ: เพื่อให้เครื่องมีอายุใช้งานยืนยาวและทำงานอย่างน่าเชื่อถือ ให้ทำการบำรุงรักษาต่อไปนี้อย่างสม่ำเสมอ

ตรวจสอบเครื่องอย่างสม่ำเสมอเพื่อหาข้อบกพร่องที่เห็นได้ชัด เช่น จุดยึดติดที่หลุดหลวม และส่วนประกอบที่เสื่อมสภาพหรือเสียหาย

ตรวจสอบว่าฝาครอบและอุปกรณ์ป้องกันไม่เสียหายและติดตั้งอย่างถูกต้องแล้ว ทำการบำรุงรักษาหรือซ่อมแซมที่จำเป็นก่อนใช้งาน

การขนส่ง

เมื่อต้องการเคลื่อนย้ายเครื่องฉีดน้ำแรงดันสูง ให้จับที่ด้ามจับด้านบน และเลื่อนเครื่องฉีดน้ำแรงดันสูงไปบนล้อ

เมื่อต้องการขนย้ายเครื่องฉีดน้ำแรงดันสูงขึ้นหรือลงชั้นบันได หรือข้ามสิ่งกีดขวาง ต้องยกเครื่องขึ้นโดยจับที่ด้ามจับด้านบน

หลังใช้งาน/เก็บเข้าที่

ทำความสะอาดส่วนภายนอกเครื่องอย่างถี่ถ้วนโดยใช้แปรงขนอ่อนหรือผ้า อย่านำน้ำ ตัวทำลาย หรือสารขัดเงา เอาเศษสกปรกทั้งหมดออก โดยเฉพาะอย่างยิ่งตรงช่องระบายอากาศ

การเก็บเข้าที่เมื่อสิ้นสุดฤดูกาล: ระบายน้ำทั้งหมดออกจากปั๊มโดยปล่อยมอเตอร์วิ่งนานสองสามวินาที และเหนียวไถเพื่อปล่อยน้ำทั้งหมด

อย่าวางวัตถุอื่นไว้ที่ด้านบนของเครื่อง

ตรวจสอบให้แน่ใจว่าสายเคเบิลไม่ถูกบีบอัดระหว่างการเก็บรักษา อย่าขจัดสายยางแรงดันสูง

การบริการหลังการขายและคำแนะนำการใช้งาน

www.bosch-do-it.com

เมื่อต้องการสอบถามและสั่งซื้ออะไหล่ กรุณาแจ้งหมายเลขสินค้าหลักบนแผ่นป้ายรุ่นของเครื่องทุกครั้ง

ไทย

บริษัท โรเบิร์ต บ็ช จำกัด
ชั้น 11 ตึกลิเบอร์ตี สแควร์
287 ถนนสีลม บางรัก
กรุงเทพฯ 10500
โทรศัพท์ 02 6393111
โทรสาร 02 2384783
บริษัท โรเบิร์ต บ็ช จำกัด ตู้ ปณ. 2054
กรุงเทพฯ 10501 ประเทศไทย
www.bosch.co.th

ศูนย์บริการซ่อมและฝึกอบรม บ็ช
อาคาร ลาซาลทาวเวอร์ ชั้น G ห้องเลขที่ 2
บ้านเลขที่ 10/11 หมู่ 16
ถนนศรีนครินทร์
ตำบลบางแก้ว อำเภอบางพลี
จังหวัดสมุทรปราการ 10540
ประเทศไทย
โทรศัพท์ 02 7587555
โทรสาร 02 7587525

การปกป้องสิ่งแวดล้อม

อย่าเทสารเคมีที่ก่อมลพิษต่อสิ่งแวดล้อมลงในพื้นดิน น้ำบาดาลหรือบ่อ แม่น้ำลำธาร ฯลฯ

สำหรับการใช้สารทำความสะอาด ให้ปฏิบัติตามคำแนะนำบนบรรจุภัณฑ์และใช้ความเข้มข้นที่กำหนดอย่างถูกต้อง

สำหรับการทำความสะอาดยานยนต์ ให้ปฏิบัติตามระเบียบข้อบังคับของท้องถิ่น: อย่าปล่อยให้ น้ำมันที่ปนออกมาไหลลงสู่บ่อบาดาล นำวัสดุติดกลับมาใช้ใหม่แทนการกำจัดของเสีย

การกำจัดขยะ

เครื่องฉีดน้ำแรงดันสูง อุปกรณ์ประกอบ และที่บ่อ ต้องนำไปแยกประเภทวัสดุเพื่อนำกลับมาใช้ใหม่โดยไม่ทำลายสภาพแวดล้อม



อย่าทิ้งเครื่องฉีดน้ำแรงดันสูงลงในถังขยะบ้าน!

สำหรับประเทศสมาชิกประชาคมยุโรปเท่านั้น:

ตามกฎหมายยุโรป 2012/19/EU สำหรับของเสียประเภทเครื่องไฟฟ้าและอิเล็กทรอนิกส์ และตามกฎหมายของประเทศที่นำกฎระเบียบยุโรปมาใช้ ต้องแยกเก็บรวบรวมเครื่องไฟฟ้าและอิเล็กทรอนิกส์ที่ไม่สามารถใช้งานต่อไปได้ และนำไปกำจัดด้วยวิธีการที่เป็นมิตรต่อสภาพแวดล้อม

ขอสงวนสิทธิ์ในการเปลี่ยนแปลงโดยไม่ต้องแจ้งล่วงหน้า

Bahasa Indonesia

Petunjuk-Petunjuk untuk Keselamatan Kerja

Penjelasan simbol-simbol



Petunjuk umum adanya bahaya.



Janganlah sekali-kali mengarahkan semprotan air pada orang, hewan, alat atau komponen-komponen listrik. Perhatian: Semprotan bertekanan tinggi bisa membahayakan, jika disalahgunakan.



Sesuai dengan peraturan-peraturan yang berlaku, alat tidak boleh disambungkan pada saluran air minum tanpa alat pemisah. Gunakanlah alat pemisah menurut peraturan IEC 61770 tipe BA.

Air yang mengalir melalui alat pemisah bukan air minum lagi. Pada penghisapan otomatis, gunakanlah set penghisapan otomatis dengan panjang 3 m (F 016 800 335).

Petunjuk-petunjuk untuk keselamatan kerja untuk penyemprot tekanan tinggi



Bacalah semua petunjuk-petunjuk untuk keselamatan kerja dan

petunjuk-petunjuk untuk penggunaan. Kesalahan dalam menjalankan petunjuk-petunjuk untuk keselamatan kerja dan petunjuk-petunjuk untuk penggunaan dapat mengakibatkan kontak listrik, kebakaran dan/atau luka-luka yang berat.

Label terkait keselamatan kerja dan label petunjuk pengoperasian yang ada pada alat memberikan petunjuk penting untuk pengoperasian yang aman.

Selain petunjuk-petunjuk dalam manual, semua peraturan tentang keselamatan kerja dan peraturan untuk menghindarkan terjadinya kecelakaan, harus ditaati.

Sambungan listrik

- ▶ Tegangan jaringan listrik harus sesuai dengan tegangan yang tercantum pada label tipe alat.
- ▶ Kami anjurkan supaya alat ini disambungkan pada stopkontak yang diamankan dengan sakelar pengaman terhadap arus penyimpangan FI (RCD) dengan kepekaan 30 mA.
- ▶ Alat ini dengan perlindungan keamanan kelas I hanya boleh disambungkan pada kontak yang mempunyai hubungan arde yang menurut peraturan.
- ▶ Cabut steker dari stopkontak, jika Anda tidak dapat mengawasi alat, juga untuk waktu yang singkat.
- ▶ Pengadaan listrik harus sesuai dengan peraturan IEC 60364-1.
- ▶ Jika kabel dari alat harus digantikan, orderkan produsen alat, satu Service Center yang resmi atau orang yang ahli dan berpengalaman untuk melakukannya, untuk menghindarkan terjadinya kecelakaan.
- ▶ Janganlah sekali-kali memegang steker jaringan dengan tangan yang basah.
- ▶ Janganlah mencabut steker selama Anda mengoperasikan alat.
- ▶ Janganlah melindas, menghimpit atau menarik kabel listrik atau kabel sambungan, karena kabel-kabel dapat menjadi rusak oleh karenanya. Lindungilah kabel terhadap suhu panas, minyak dan tepian yang tajam.
- ▶ Janganlah menggunakan alat jika kabel listrik atau komponen-komponen yang penting, seperti misalnya slang tekanan tinggi, pistol penyemprotan atau sarana-sarana pelindung rusak.
- ▶ Perhatian: kabel-kabel sambungan yang tidak memenuhi peraturan bisa membahayakan.
- ▶ Jika digunakan kabel sambungan, steker dan kopleng harus kedap air. Kabel sambungan harus mempunyai penampang lintang yang disebutkan dalam petunjuk-petunjuk dalam manual dan terlindungi terhadap semprotan air. Sambungan tidak boleh berada dalam air.

- ▶ Jika steker pada kabel jaringan atau kabel sambungan digantikan, perlindungan terhadap semprotan air dan stabilitas mekanik harus dipertahankan.

Sambungan air

- ▶ Perhatikanlah peraturan-peraturan dari perusahaan penyedia air Anda.
- ▶ Sambungan semua slang-slang harus kedap air.
- ▶ Alat ini mutlak harus disambungkan dengan pentil arus balik pada saluran air minum. Air yang mengalir melalui pentil arus balik dianggap tidak dapat diminum.
- ▶ Slang tekanan tinggi tidak boleh dalam keadaan rusak (bahaya pecah). Slang tekanan tinggi yang rusak harus langsung digantikan. Hanya slang-slang dan sambungan-sambungan yang dianjurkan oleh produsen alat yang diizinkan untuk dipakai.
- ▶ Slang-slang tekanan tinggi, pesawat dalam dan kopling-kopling sangat penting untuk keselamatan kerja dengan alat. Gunakanlah hanya slang-slang, pesawat dalam dan kopling-kopling yang dianjurkan oleh produsen alat.
- ▶ Pada sambungan air masuk hanya boleh digunakan air yang bersih atau air yang disaring.

Penggunaan

- ▶ Alat dengan aksesorinya harus diperiksa apakah keberadaannya memenuhi peraturan dan dapat digunakan secara aman, sebelum pengoperasiannya. Jika keberadaannya tidak mulus, alat tidak boleh dioperasikan.
- ▶ Janganlah mengarahkan semprotan air pada diri sendiri atau orang lain untuk membersihkan pakaian atau sepatu.
- ▶ Cairan yang mengandung pelarut, zat asam yang tidak diencerkan, aseton atau cairan pelarut termasuk bensin, tiner dan minyak solar tidak boleh dihisap, karena kabut penyemprotannya sangat mudah terbakar, dapat meledak dan beracun.
- ▶ Jika alat digunakan di tempat yang berbahaya (misalnya pompa bensin), peraturan-peraturan terkait harus ditaati. Alat tidak boleh dioperasikan di ruangan yang terancam bahaya ledakan.
- ▶ Alat ini harus ditempatkan pada alas yang keras dan datar.
- ▶ Pada penggunaan di dalam ruang tertutup, perhatikanlah supaya ada pertukaran udara yang memadai. Perhatikanlah supaya kendaraan selama pembersihannya berada dalam keadaan mati (motor mati).
- ▶ Pengoperasian penyemprot tekanan tinggi harus dengan kedua belah tangan. Janganlah menggunakannya di atas tangga. Pada penggunaan di balkon atau tempat tinggi lainnya, perhatikanlah supaya Anda setiap saat melihat semua sisinya.
- ▶ Gunakanlah hanya deterjen yang dianjurkan oleh produsen alat dan taatilah petunjuk-petunjuk untuk

44 | Bahasa Indonesia

- penggunaan, pembuangan dan keselamatan kerja dari produsennya.
- ▶ Semua saluran listrik di bidang kerja harus dilindungi terhadap semprotan air.
 - ▶ Tuas untuk mengoperasikan pistol penyemprotan selama penggunaan tidak boleh dijepit pada posisi „ON“.
 - ▶ Pakailah pakaian pelindung yang tahan air semprotan. Janganlah mengoperasikan alat di dekat orang-orang lain, kecuali orang-orang ini memakai pakaian pelindung.
 - ▶ Jika perlu, pakailah sarana pelindung (PPE/Personal Protective Equipment) yang cocok untuk semprotan air, misalnya kacamata pelindung, masker pelindung terhadap debu dsb., untuk melindungi terhadap air, partikel dan/atau aerosol yang dipantulkan dari benda-benda.
 - ▶ **Pada penggunaan penyemprot tekanan tinggi dapat terjadi aerosol.** Menghirup aerosol berbahaya bagi kesehatan.
 - ▶ Tekanan yang tinggi dapat membanting benda-benda. Jika perlu, pakailah sarana untuk melindungi diri, misalnya kacamata pelindung.
 - ▶ Untuk menghindarkan terjadinya kerusakan oleh semprotan tekanan tinggi, ban kendaraan/pentil hanya boleh dibersihkan dengan jarak minimal 30 cm. Gejala dini untuk hal ini adalah perubahan warna dari ban. Ban kendaraan/pentil yang rusak sangat membahayakan.
 - ▶ Bahan-bahan yang mengandung asbes atau bahan-bahan lain yang mengandung zat yang berbahaya bagi kesehatan, tidak boleh disemprot.
 - ▶ Janganlah menggunakan deterjen yang dianjurkan yang belum diencerkan. Produk-produk ini tidak membahayakan karena tidak mengandung zat asam, alkali atau zat yang berbahaya bagi lingkungan hidup. Kami anjurkan supaya deterjen disimpan di luar jangkauan anak-anak. Jika mata terkena deterjen, mata harus segera dicuci dengan banyak air, jika deterjen tertelan, segera hubungi dokter.
 - ▶ **Janganlah sekali-kali mengoperasikan penyemprot tekanan tinggi tanpa filter, dengan filter yang kotor atau yang rusak.** Jika penyemprot tekanan tinggi digunakan tanpa atau dengan filter yang kotor atau rusak, garansi tidak berlaku lagi.
 - ▶ Bagian-bagian dari logam dapat menjadi panas jika alat dioperasikan untuk waktu yang lama. Jika perlu, pakailah sarung tangan pelindung.
 - ▶ Jika cuaca buruk, khususnya sebelum ada badai guntur, janganlah mengoperasikan penyemprot tekanan tinggi.

Pengoperasian

- ▶ Orang yang mengoperasikan alat harus menggunakan alat sesuai dengan penjelasan dalam manual terkait penggunaannya. Keberadaan lokal harus diperhatikan. Selama

bekerja dengan alat, penting sekali untuk memperhatikan orang lain, terutama anak-anak.

- ▶ Alat ini hanya boleh dioperasikan oleh orang-orang yang telah mendapat penjelasan tentang cara penggunaan dan pengendaliannya atau dapat membuktikan, bahwa ia dapat mengoperasikan alat. Alat ini tidak boleh digunakan oleh anak-anak atau orang muda.
- ▶ Janganlah sekali-kali mengizinkan anak-anak, orang-orang yang kurang mampu secara fisik, sensoris atau mental atau kurang pengalaman dan/atau kurang mengetahui dan/atau orang-orang yang tidak mengenal petunjuk-petunjuk ini, menggunakan alat untuk pemeliharaan taman ini. Bisa jadi ada peraturan nasional yang menentukan batas usia pengguna alat ini.
- ▶ Awasilah anak-anak dan perhatikan supaya anak-anak tidak menggunakan alat untuk pemeliharaan taman ini sebagai mainan.
- ▶ Alat ini tidak boleh ditinggalkan tanpa pengawasan, jika alat hidup.
- ▶ Semprotan air yang keluar dari spuyer tekanan tinggi mengakibatkan bantingan. Oleh karena itu pistol penyemprotan dan spuyer bergagang panjang harus dipegang kencang dengan kedua belah tangan.

Transpor

- ▶ Sebelum mengangkut alat ini, alat harus dimatikan dan diamankan.

Merawat

- ▶ Matikan alat sebelum Anda melakukan pekerjaan pembersihan dan perawatan dan sebelum mengganti aksesori. Cabutkan steker, jika alat disambungkan pada jaringan listrik.
- ▶ Reparasi hanya boleh dilakukan oleh bengkel Service Center Bosch yang resmi.

Aksesori dan suku cadang

- ▶ Hanya aksesori dan suku cadang yang diizinkan oleh Bosch yang boleh digunakan. Aksesori asli dan suku cadang asli menjamin pengoperasian tanpa storing.

Simbol-Simbol

Simbol-simbol berikut penting pada waktu membaca dan untuk mengerti petunjuk-petunjuk untuk penggunaan. Lihat dan ingati simbol-simbol dan artinya. Penafsiran yang betul dari simbol-simbol sangat membantu Anda untuk menggunakan perkakas listrik dengan jitu dan sesuai dengan petunjuk untuk keselamatan kerja.

Simbol	Arti
	Arah gerakan
	Berat
	hidup
	mati
Lo	Tekanan rendah
Hi	Tekanan tinggi
	Aksesori

Penggunaan alat

Alat ini cocok untuk membersihkan permukaan dan obyek-obyek di luar gedung, mesin, kendaraan dan kapal, jika digunakan aksesori yang cocok, misalnya deterjen yang diizinkan oleh Bosch.

Penjelasan terkait penggunaan alat berlaku untuk suhu keliling antara 0 °C dan 40 °C.

46 | Bahasa Indonesia

Data teknis

Penyemprot tekanan tinggi		GHP 8-15 XD
Nomor model		3 600 J10 3..
Masukan nominal	kW	4
Suhu air masuk maks.	°C	50
Banyaknya air masuk min.	l/min	12,6
Tekanan nominal	MPa	15
Tekanan kerja maks.	MPa	16
Arus lintang	l/min	12,6
Banyaknya air masuk min.	MPa	1
Tenaga bantingan spuyer bergagang panjang pada tekanan maks.	N	33,24
Isolasi motor		Kelas F
Jenis perlindungan motor		IPX5
Tangki deterjen		l
Fungsi Autostop		●
Impedansi jaringan		-
Tekanan bunyi	dB(A)	85,5
Ketidak tepatan	dB(A)	3
Nilai tenaga bunyi	dB(A)	93
Ketidak tepatan	dB(A)	3
Nilai jumlah getaran	m/s ²	4,91
Ketidak tepatan	m/s ²	1,5
Berat sesuai dengan EPTA-Procedure 01:2014	kg	40,6
Klasifikasi keamanan		⊕ / I
Nomor serial	lihat nomor model (label tipe) pada penyemprot tekanan tinggi	

Data-data berlaku untuk tegangan nominal [U] 230 V. Pada tegangan yang lebih rendah dan pada model khusus mancanegara data-data ini bisa berlainan.

Pada saat perkakas listrik dihidupkan, bisa terjadi penurunan tegangan dalam jaringan listrik untuk waktu yang pendek. Jika jaringan tidak memenuhi syarat, bisa terjadi gangguan terhadap alat-alat listrik lainnya. Jika impedansi jaringan di bawah 0,153 Ohm, tidak akan terjadi gangguan.

Memasang dan menggunakan

Kegiatan	Gambar	Halaman
Pasokan standar	1	59
Memasang pegangan	2	60
Memasang slang	3	61
Memasang spuyer ventilasi	4	62
Mengisi tangki deterjen	5	62
Sambungan air	6	63
Membersihkan filter	7	63
Menyambungkan slang tekanan tinggi/pistol penyemprotan	8	64

Kegiatan	Gambar	Halaman
Menyetel tekanan	9	64
Menyetel semprotan spuyer	10	65
Menghidupkan/mematikan	11	65
Membersihkan spuyer	12	65

Cara menggunakan**Demi keselamatan Anda**

Perhatian! Sebelum melakukan pekerjaan untuk merawat atau membersihkan, matikan peralatan kebun ini dan cabutkan stekernya. Hal yang sama berlaku jika kabel listrik rusak, terpotong atau tersangkut.

Peralatan kebun ini dijadikan aman dengan isolasi dan tidak harus diadakan hubungan arde. Tegangan selama beroperasi 230 V AC, 50 Hz (di negara-negara bukan anggota UE juga 220 V atau 240 V).

Untuk meningkatkan keselamatan, gunakanlah sakelar pengaman terhadap arus penyimpangan FI (RCD) dengan kepekaan maksimal 30 mA. Sakelar pengaman RCD ini harus diperiksa sebelum setiap penggunaan.

Kabel listrik dan kabel sambungan secara berkala harus diperiksa apakah ada kerusakannya dan hanya boleh digunakan dalam keadaan mulus.

Jika kabel listrik harus digantikan, pekerjaan ini harus dilakukan oleh Bosch atau Service Center untuk perkakas listrik Bosch yang resmi, supaya keselamatan kerja selalu terjamin.

Gunakanlah hanya kabel sambungan yang diizinkan penggunaannya.



HATI-HATI: Kabel sambungan yang tidak memenuhi peraturan bisa membahayakan. Kabel sambungan, steker dan kopling harus kedap air dan diizinkan untuk penggunaan di luar gedung.

Gunakanlah hanya kabel sambungan, saluran sambungan atau tromol kabel (cable drum) yang memenuhi norma EN 61242 / IEC 61242 atau IEC 60884-2-7.

Jika untuk mengoperasikan peralatan dibutuhkan kabel sambungan, diperlukan penampang lintang berikut:

- penampang lintang 1,5 mm² untuk kabel sambungan sampai kepanjangan maksimal 20 m

Sambungan kabel (steker dan stopkontak) harus kering dan tidak boleh terletak di atas tanah.

Untuk tujuan ini kami sarankan supaya digunakan tromol kabel yang stopkontaknya berada paling sedikit 60 mm di atas tanah.

Petunjuk: Jika digunakan kabel sambungan, kabel sambungan – seperti yang dijelaskan dalam peraturan keselamatan kerja – harus dilengkapi dengan penghantar kontak badan, yang disambungkan melalui steker dengan penghantar kontak badan dari instalasi listrik Anda.

Taatilah petunjuk untuk penggunaan kabel sambungan dan tromol kabel dari produsennya serta peraturan-peraturan nasional terkait penggunaannya.

Jika Anda ragu-ragu, mintakan penjelasan dari orang ahli listrik yang berpengalaman atau Service Center Bosch terdekat.

Petunjuk untuk produk-produk yang **tidak dijual di GB:**

PERHATIAN: Demi keselamatan Anda, steker pada peralatan kebun ini harus dikencangkan pada kabel sambungan. Kopling dari kabel sambungan harus dilindungi terhadap air semprotan, terdiri dari karet atau dilapisi dengan bahan karet. Kabel sambungan harus digunakan dengan pengikatan kabel terhadap tarikan.

Menghisap air dari wadah yang terbuka

- Sambungkan slang penghisapan dengan filter (set slang penghisapan khusus no. model F 016 800 335) pada sambungan air.
- Hidupkan alat pada penyetelan tekanan rendah.
- Biarkan alat jalan selama kira-kira 10 detik dan kemudian matikan alat. Ulangi tindakan ini beberapa kali, sampai air mengalir rata dan bebas gelembung.

Perhatikanlah bahwa alat ini tidak boleh dioperasikan tanpa air.

Penggunaan

Menghidupkan

Slang air (tidak termasuk pasokan) disambungkan pada pengadaan air dan alat.

Perhatikanlah supaya sakelar listrik berada pada posisi „0“ dan sambung alat pada stopkontak.

Buka keran air.

Gerakkan penguncian penghidupan , untuk membuka penguncian pelatuk . Tekan pelatuk sampai batas, hingga air mengalir rata dan tidak ada udara dalam alat dan slang tekanan tinggi. Pelatuk dilepaskan.

Arahkan pistol penyemprotan ke bawah. Gerakkan penguncian penghidupan , untuk membuka penguncian pelatuk . Tekan pelatuk sampai batas.

Gerakkan tombol untuk menghidupkan dan mematikan.

Fungsi Autostop

Alat mematikan motor segera setelah pelatuk pada gagang pistol penyemprotan dilepaskan.

Petunjuk-petunjuk untuk pemakaian

Petunjuk umum

Perhatikanlah supaya penyemprot tekanan tinggi berada pada alas yang datar.

Janganlah menarik slang tekanan tinggi terlalu jauh ke depan atau jangan menarik penyemprot tekanan tinggi pada slangnya. Hal ini bisa mengakibatkan penyemprot tekanan tinggi tidak stabil dan terbalik.

Janganlah menekukkan slang tekanan tinggi dan jangan menindas dengan kendaraan di atasnya. Lindungi slang tekanan tinggi terhadap pinggiran atau tepian yang tajam.

Janganlah menggunakan spuyer rotasi untuk mencuci mobil.

Janganlah melakukan perubahan atau penyetelan yang tidak diizinkan pada pentil keamanan.

Tongkat ukur minyak

Penyemprot tekanan tinggi dipasang dengan kap penutup minyak yang dipasangkan selama penyimpanan alat dan kap dengan lubang ventilasi (tongkat ukur minyak) yang dipasangkan selama penggunaan alat.

Petunjuk-petunjuk untuk penggunaan untuk membersihkan dengan deterjen

- **Gunakanlah hanya deterjen yang pasti cocok untuk digunakan dengan penyemprot tekanan tinggi.**

Demi perlindungan lingkungan hidup, kami anjurkan supaya deterjen digunakan secara hemat. Taatilah petunjuk untuk mengencerkan deterjen yang tercantum pada labelnya.

Dengan menawarkan bahan pembersih dan bahan konservasi terpilih, Bosch menjamin penggunaan alat tanpa stiring.

Cara membersihkan yang dianjurkan

Langkah 1: Melarutkan kotoran

Semprotkan sedikit deterjen dan biarkan berreaksi sebentar.

Langkah 2: Menyingkirkan kotoran

Singkirkan kotoran yang larut dengan tekanan yang tinggi.

Petunjuk: Jika membersihkan permukaan yang tegak lurus, mulailah menyemproti kotoran/menyemprotkan deterjen dari bawah ke atas. Jika membilas, mulailah dari atas ke bawah.

48 | Bahasa Indonesia

Mengatasi storing

Gejala	Sebab yang mungkin	Tindakan untuk mengatasi
Motor tidak menstart	Steker tidak disambungkan	Steker disambungkan
	Stopkontak rusak	Gunakan stopkontak lain
	Sekering putus	Gantikan sekering
	Kabel sambungan rusak	Coba tanpa kabel sambungan
	Perlindungan motor aktif	Motor didinginkan 15 men.
	Beku	Pompa, slang air atau aksesoris dibiarkan menjadi hangat
Motor berhenti	Sekering putus	Gantikan sekering
	Tegangan jaringan tidak cocok	Periksa tegangan jaringan, harus sesuai dengan data pada label tipe alat
	Perlindungan motor aktif	Motor didinginkan 15 men.
Sekering putus	Sekering terlalu kecil ampere nominalnya	Sambungkan pada jaringan listrik dengan ampere yang cocok untuk penyemprot tekanan tinggi
Motor menstart, tetapi tidak ada tekanan	Spuyer agak tersumbat	Membersihkan spuyer
Ada bunyi motor tetapi tidak berfungsi	Tegangan jaringan tidak memadai	Periksalah apakah tegangan jaringan listrik sesuai dengan data pada label tipe alat.
	Tegangan terlalu rendah karena digunakan kabel sambungan	Periksalah apakah kabel sambungan cocok
	Alat tidak dipakai untuk waktu yang lama	Hubungi Service Center Bosch yang resmi
	Masalah dengan fungsi Autostop	Hubungi Service Center Bosch yang resmi
Tekanan berdenyut	Ada udara dalam slang air atau pompa	Penyemprot tekanan tinggi dijalankan dengan pistol penyemprotan terbuka, keran air terbuka dan spuyer pada tekanan rendah sampai tercapai tekanan kerja yang rata.
	Pengadaan air tidak cocok	Periksalah apakah sambungan air sesuai dengan data dalam bab data teknis. Slang air terkecil yang boleh dipakai adalah 1/2" atau Ø 13 mm
	Filter air tersumbat	Bersihkan filter air
	Slang air terhimpit atau tertekuk	Luruskan slang air
	Slang tekanan tinggi terlalu panjang	Lepaskan slang sambungan dari slang tekanan tinggi, panjang slang air maks. 7 m
Tekanan rata tetapi terlalu rendah Petunjuk: Aksesoris tertentu mengakibatkan tekanan yang rendah	Spuyer usang	Gantikan spuyer
	Pentil start/stop usang	Pelatuk digerakkan 5 kali berturut-turut secara cepat
Motor menstart, tetapi tekanan terbatas atau tidak ada tekanan kerja	Air tidak disambungkan	Sambungkan air
	Filter tersumbat	Membersihkan filter
	Spuyer tersumbat	Bersihkan spuyer
Penyemprot tekanan tinggi menstart sendiri	Pompa atau pistol penyemprotan bocor	Hubungi Service Center Bosch yang resmi
Alat bocor	Pompa bocor	Kebocoran air sedikit tidak apa-apa; jika ada kebocoran yang besar, hubungi Service Center Bosch

Gejala	Sebab yang mungkin	Tindakan untuk mengatasi
Deterjen tidak dihisap	Spuyer yang bisa disetel berada pada penyetelan tekanan tinggi	Setelkan spuyer pada „Lo“
	Deterjen terlalu kental	Encerkkan dengan air
	Slang tekanan tinggi diperpanjang	Sambungkan slang asli
	Ada endapan atau penyempitan dalam peredaran deterjen	Bilas dengan air bersih dan hilangkan penyempitan. Jika masalah tidak teratasi, hubungi Service Center Bosch.

Rawatan dan servis

Merawat

- **Sebelum melakukan pekerjaan pada alat, cabut steker dan putuskan sambungan air.**

Petunjuk: Lakukanlah pekerjaan rawatan berikut secara berkala, supaya alat tahan lama dan berfungsi dengan baik.

Periksalah alat secara berkala, apakah terlihat ada kekurangan, seperti misalnya sambungan yang kendur atau bagian-bagian yang usang atau rusak.

Periksalah apakah sarana-sarana penutup dan pelindung mulus dan terpasang dengan betul. Jika perlu, sebelum menggunakan alat, lakukanlah pekerjaan rawatan atau reparasi.

Transpor

Untuk menggerakkan penyemprot tekanan tinggi, pegang alat pada pegangan di atas dan gerakkan pada rodanya ke tempat yang dituju.

Untuk memindahkan penyemprot tekanan tinggi melewati tangga atau hambatan lainnya, pegang alat pada pegangan di atas dan angkatkannya.

Setelah penggunaan/menyimpan

Bagian luar dari penyemprot tekanan tinggi dibersihkan dengan sikat yang lunak dan lap. Air, tiner dan bahan untuk memolis tidak boleh digunakan. Singkirkan semua kotoran, terutama lubang ventilasi dari motor harus dibersihkan.

Menyimpan setelah musim penggunaan berakhir: Keluarkan semua air dari pompa dengan cara membiarkan motor jalan beberapa detik dan pelatuk digerakkan.

Janganlah meletakkan barang-barang lain di atas alat. Perhatikanlah supaya kabel selama alat disimpan tidak terjepit. Janganlah menekuk slang tekanan tinggi.

Layanan pasca beli dan konseling terkait pengoperasian

www.bosch-do-it.com

Jika Anda hendak menanyakan sesuatu atau memesan suku cadang, sebutkan selalu nomor model yang terdiri dari 10 angka dan tercantum pada label tipe alat.

Indonesia

PT Robert Bosch
Palma Tower 10th Floor
Jl. RA Kartini II-S Kaveling 6 Sek II
Pondok Pinang, Kebayoran Lama
Jakarta Selatan 12310
Tel.: (021) 3005 5800
Fax: (021) 3005 5801
E-Mail: boschpowertools@id.bosch.com
www.bosch-pt.co.id

Melindungi lingkungan hidup

Bahan kimia yang berbahaya bagi lingkungan hidup tidak boleh mengalir ke dalam tanah, air tanah, kolam, sungai dan sebagainya.

Jika digunakan deterjen, taatilah petunjuk pada kemasan dan konsentrasi yang disebutkan dengan seksama.

Jika membersihkan kendaraan bermotor, taatilah peraturan-peraturan setempat: minyak yang tersemprot mutlak tidak boleh merembes ke dalam air tanah.

Cara membuang

Penyemprot tekanan tinggi, aksesoris dan kemasan sebaiknya didaur ulang sesuai dengan upaya untuk melindungi lingkungan hidup.



Janganlah membuang penyemprot tekanan tinggi dalam sampah rumah tangga!

Hanya untuk negara-negara UE:

Sesuai dengan peraturan Eropa 2012/19/EU terkait alat-alat elektro dan elektronika yang tidak dipakai lagi dan penerapannya dalam peraturan nasional mancanegara, alat-alat elektro dan elektronika yang rusak harus dikumpulkan secara terpisah dan didaur ulang sesuai dengan upaya untuk melindungi lingkungan hidup.

Perubahan dapat terjadi tanpa pemberitahuan sebelumnya.

Tiếng Việt

Các Nguyên Tắc An Toàn

Giải thích các biểu tượng



Cảnh báo tổng quát các nguy hiểm vì sự an toàn.



Không bao giờ được hướng trực tiếp tia nước vào người, thú vật, các thiết bị hay bộ phận điện. Cảnh báo: Tia nước cao áp có thể gây nguy hiểm nếu bị sử dụng sai cách.



Dựa trên các quy định về việc ứng dụng, không bao giờ được sử dụng mạng nước uống được cho thiết bị ứng dụng mà không có hệ thống tách. Sử dụng hệ thống tách phù hợp với qui chuẩn IEC 61770 Type BA.

Nước chảy qua hệ thống tách được xem là nước không thể uống được.

Đối với sự tự mỗi nước, sử dụng bộ hút đặc biệt dài 3 m (F 016 800 335).

Chú Thích An Toàn cho máy phun rửa cao áp



Đọc kỹ mọi cảnh báo an toàn và mọi hướng dẫn. Không tuân thủ mọi cảnh báo và hướng dẫn được liệt kê dưới đây có thể bị điện giật, gây cháy và/hay bị thương tật nghiêm trọng.

Sự cảnh báo và các ký hiệu thông tin đính kèm theo thiết bị cung cấp các thông tin quan trọng cho sự vận hành an toàn.

Ngoài các thông tin trong hướng dẫn sử dụng, hãy tuân theo các qui định về an toàn chung và các qui định về phòng chống tai nạn.

Nguồn điện cung cấp

- ▶ Điện thế ghi trong trong biển thông số phải phù hợp với điện thế nguồn.
- ▶ Chúng tôi khuyến nghị thiết bị này chỉ nối vào ổ cắm có bộ ngắt mạch bảo vệ. Bộ ngắt mạch này sẽ khởi hoạt khi phát sinh dòng điện dư 30 mA.
- ▶ Đây là thiết bị loại I và có thể chỉ được đấu nối vào nguồn điện được tiếp đất thích hợp.
- ▶ Rút phích ra khỏi ổ cắm bất cứ khi nào máy để không, bất kể thời gian lâu mau.
- ▶ Các thiết bị cấp nối điện phải đáp ứng Qui chuẩn IEC 60364-1.
- ▶ Nếu dây cung cấp điện bị hư hỏng, dây phải do nhà cung cấp hoặc các đại lý dịch vụ hoặc do thợ chuyên môn thay để tránh nguy hiểm.
- ▶ Không bao giờ được chạm vào phích cắm nguồn bằng tay ướt.
- ▶ Không được rút phích cắm khi đang vận hành thiết bị.
- ▶ Không được cán qua, làm gấp hay kéo cáp cung cấp điện hay

dây nối dài, nếu không, dây có thể bị hư hỏng. Bảo vệ cáp tránh nhiệt, dầu nhờn hay các cạnh bén.

- ▶ Không được sử dụng thiết bị ứng dụng nếu cấp cung cấp điện hay các bộ phận quan trọng khác vd. vòi chịu áp suất cao, cần bóp hay các thiết bị an toàn bị hư hại.
- ▶ Cảnh báo: Dây nối dài không thích hợp có thể trở nên nguy hiểm.
- ▶ Nếu sử dụng một dây nối dài, phích cắm và ổ cắm phải có cấu tạo chống thấm nước. Dây nối dài phải có mặt cắt ngang phù hợp với các hướng dẫn sử dụng và chống được nước bắn vào. Các đầu nối không được nằm trong nước.
- ▶ Khi thay các phích cắm trên cấp cung cấp điện hay dây nối dài, chấn bụi nước và sự ổn định cơ học phải được duy trì không thay đổi.

Nối nước vào

- ▶ Tuân theo các qui định của công ty cấp nước của bạn.
- ▶ Tất cả các vòi nối phải có các ron bịt kín khớp nối phù hợp.
- ▶ Không bao giờ được sử dụng thiết bị ứng dụng với nguồn nước uống được mà không có van chặn ngược dòng. Nước chảy ngược qua van chặn ngược dòng được xem là nước không thể uống được.

- ▶ Không để cho vòi chịu áp suất cao bị hư hại (nguy cơ toát ra). Vòi chịu áp suất cao bị hư hỏng phải được thay ngay. Chỉ sử dụng vòi và các chi tiết kết nối do nhà sản xuất khuyến nghị.
- ▶ Vòi chịu áp suất cao, các đầu nối vòi và khớp nối rất quan trọng cho sự an toàn của thiết bị ứng dụng. Chỉ sử dụng các vòi, đầu nối vòi và khớp nối do nhà sản xuất khuyến nghị.
- ▶ Chỉ nên sử dụng nước sạch hay đã được lọc để đưa vào máy.

Ứng dụng

- ▶ Trước khi sử dụng, kiểm tra thiết bị và thiết bị thao tác có trạng thái hoàn hảo và an toàn để sử dụng. Không được sử dụng thiết bị nếu như thiết bị không trong tình trạng hoàn hảo.
- ▶ Không được hướng thẳng tia nước vào chính người bạn hay người khác để làm sạch quần áo hay giày dép.
- ▶ Không bao giờ được đưa vào các loại dung môi lỏng, axit nguyên chất, aceton hay dung môi hòa tan! Điều này bao gồm xăng, dung môi pha sơn, dầu đốt lò sưởi. Các bụi sương này rất dễ cháy, nổ và độc hại.
- ▶ Các qui định phù hợp về an toàn phải được tuân theo khi sử dụng thiết bị ở những khu vực nguy hiểm (vd. trạm xăng dầu). Ở những nơi tiềm ẩn nguy cơ gây nổ cao là nơi cấm sử dụng thiết bị.

52 | Tiếng Việt

- ▶ Thiết bị phải được đặt trên một bề mặt vững chắc.
- ▶ Hãy lưu ý nếu như sử dụng máy trong một không gian hẹp, hãy bảo đảm rằng nơi này được thông thoáng. Nhớ chắc rằng tất cả các xe phải được tắt máy trong suốt thời gian phun rửa.
- ▶ Vận hành thiết bị này luôn luôn cần dùng đến cả hai tay. Không đứng trên thang khi sử dụng thiết bị. Bảo đảm khi sử dụng máy ở ban-công hay các nơi cao khác, bạn chắc chắn là luôn luôn nhìn thấy được các cạnh bên.
- ▶ Chỉ sử dụng chất tẩy rửa do nhà sản xuất kiến nghị và tuân theo cách ứng dụng, thải bỏ và các cảnh báo an toàn của nhà sản xuất chất tẩy rửa.
- ▶ Tất cả các bộ phận dẫn điện trong khu vực làm việc phải được bảo vệ, ngăn không cho nước bắn vào.
- ▶ Cò của cần bóp phải không bị kẹt khi ở vị trí "ON" trong khi hoạt động.
- ▶ Mặc quần áo bảo hộ thích hợp để bảo vệ từ các vật bị bắn tung ra. Không được sử dụng thiết bị ứng dụng trong phạm vi có người, trừ khi họ cũng mặc quần áo bảo hộ.
- ▶ Nếu cần, hãy mang các trang thiết bị bảo hộ cá nhân (PPE) như kính bảo hộ an toàn, mặt nạ bảo vệ hô hấp v.v.. để ngăn nước, các mảnh nhỏ và/hay bụi nước từ các bộ phận phun ngược lại.
- ▶ **Trong quá trình sử dụng máy phun rửa cao áp, máy có thể tạo ra xon khí.** Hít phải xon khí có thể gây nguy hại đến sức khỏe.
- ▶ Áp suất cao có thể làm cho các đồ vật bật nảy lên. Nếu cần, hãy trang bị thiết bị bảo hộ cá nhân như kính bảo hộ chẳng hạn.
- ▶ Có thể chỉ nên rửa sạch lốp xe/van lốp xe từ một khoảng cách tối thiểu là 30 cm, nếu không, tia nước cao áp có thể làm hư hại lốp xe/van lốp xe. Sự báo hiệu đầu tiên là sự bay màu của lốp xe. Làm hư hại lốp xe/van lốp xe có thể là sự cực kỳ nguy hiểm.
- ▶ Bạn không được phun rửa các loại vật liệu có hại cho sức khỏe như vật liệu chứa amiăng hoặc có chứa các chất độc hại khác.
- ▶ Không được sử dụng các chất tẩy rửa khi chưa được pha loãng. Các sản phẩm an toàn khi sử dụng là các chất không chứa axit, kiềm hay các chất gây hại cho môi trường. Chúng tôi đề nghị nên để các chất tẩy rửa ra ngoài tầm với của trẻ em. Nếu bị chất tẩy rửa văng vào mắt, rửa thật nhiều nước và nếu nuốt phải, phải đi khám bác sĩ ngay lập tức.
- ▶ **Không bao giờ được sử dụng máy phun rửa cao áp mà không có bộ lọc hay bộ lọc đơ hay đã bị hư.** Sử dụng máy

phun rửa áp cao áp mà không có bộ lọc hay bộ lọc dơ hay đã bị hư có thể không có giá trị bảo hành.

- ▶ Các bộ phận kim loại có thể trở nên nóng sau thời gian dài sử dụng. Nếu cần, hãy mang găng bảo vệ tay.
- ▶ Tránh không rửa với áp suất cao trong tình trạng thời tiết xấu, đặc biệt là khi có nguy cơ có sấm sét.

Vận hành

- ▶ Người vận hành phải sử dụng thiết bị đúng theo các qui định. Ông/bà phải xem xét đến các điều kiện của địa phương và lưu ý đến những người chung quanh, đặc biệt là trẻ em khi vận hành thiết bị.
- ▶ Thiết bị có thể chỉ được dành cho người đã biết cách sử dụng hay chứng tỏ được năng lực vận hành. Không được để cho trẻ con hay trẻ vị thành niên sử dụng thiết bị (nguy hiểm gây ra tai nạn do sử dụng thiết bị không đúng cách).
- ▶ Không bao giờ cho phép trẻ con, người thiếu năng, người có hạn chế về thể lực, khiếm khuyết giác quan hay không có kinh nghiệm/hoặc người không biết rõ các hướng dẫn này sử dụng dụng cụ làm vườn. Có thể có các quy định của địa phương về tuổi của người sử dụng.
- ▶ Phải để ý đến trẻ con để bảo đảm chúng không nghịch máy.

- ▶ Không bao giờ được để thiết bị hoạt động để không mà không có sự giám sát.
- ▶ Tia nước từ miệng vòi cao áp tạo ra sự dội lại trên cần bóp. Vì thế bạn nên giữ cần bóp và cần phun thật chặt bằng cả hai tay.

Vận chuyển

- ▶ Tắt mô-tơ và ràng buộc chắc chắn thiết bị trước khi vận chuyển.

Bảo trì

- ▶ Tắt thiết bị trước khi thực hiện mọi công việc như làm sạch, bảo trì và trước khi thay các bộ phận. Rút phích cắm nếu như thiết bị sử dụng điện nguồn.
- ▶ Sự sửa chữa có thể chỉ do các Trung Tâm Dịch Vụ Bosch thực hiện.

Phụ kiện và phụ tùng thay thế

- ▶ Chỉ sử dụng phụ kiện và phụ tùng thay thế đã được hãng Bosch chấp nhận. Phụ kiện và phụ tùng thay thế chính hãng bảo đảm cho thiết bị có thể hoạt động an toàn và không gặp bất cứ hỏng hóc nào.

Các Biểu Tượng

Các biểu tượng sau đây mang ý nghĩa quan trọng để suy diễn và hiểu các hướng dẫn sử dụng. Xin vui lòng lưu ý đến các biểu tượng và ý nghĩa của chúng. Sự hiểu đúng các biểu tượng sẽ giúp bạn sử dụng máy một cách tốt và an toàn hơn.

Biểu Tượng	Ý Nghĩa
	Chiều chuyển động

54 | Tiếng Việt

Biểu Tượng	Ý Nghĩa
	Trọng lượng
	Mở
	Tắt
Lo	Áp suất thấp
Hi	Áp suất cao
	Phụ kiện

Dành sử dụng cho

Sản phẩm dành để làm sạch bề mặt và các vật dụng nằm bên ngoài nhà, dụng cụ, xe cộ và ghe thuyền nếu như sử dụng các phụ kiện thích hợp như chất tẩy rửa được Bosch chấp nhận.

Mục đích sử dụng liên quan đến hoạt động với nhiệt độ chung quanh trong phạm vi 0 °C và 40 °C.

Thông số kỹ thuật

Máy phun rửa cao áp	GHP 8-15 XD	
Mã số máy	3 600 J10 3..	
Công suất danh định	kW	4
Nhiệt độ cung cấp tối đa	°C	50
Năng suất cung cấp tối thiểu	l/min	12,6
Áp suất làm việc	MPa	15
Áp suất hoạt động tối đa	MPa	16
Tốc độ dòng chảy	l/min	12,6
Áp suất vào tối đa	MPa	1
Lực đẩy tại cần bóp ở áp suất tối đa	N	33,24
Động Cơ được Cách Điện	Loại F	
Bảo Vệ Động Cơ	IPX5	
Bình chứa chất tẩy rửa	l	
Chức năng ngừng tự động	●	
Trở kháng thực	-	
Cấp độ áp lực âm thanh	dB(A)	85,5
Bất định	dB(A)	3
Cấp độ công suất âm thanh	dB(A)	93
Bất định	dB(A)	3
Tổng trị số độ rung	m/s ²	4,91
Bất định	m/s ²	1,5

Các giá trị đã cho có hiệu lực cho điện thế danh định [U] 230 V. Đối với điện thế thấp hơn và các loại máy dành riêng cho một số quốc gia, các giá trị này có thể thay đổi.

Chu trình khởi động làm giảm điện áp xảy ra thoáng nhanh. Sự gây nhiễu động đối với các thiết bị/máy móc khác có thể xảy ra trong trường hợp ở vào tình trạng không thuận lợi của hệ thống điện nguồn. Không có sự cố xảy ra đối với hệ thống có trở kháng dưới 0,153 ohm.

Máy phun rửa cao áp	GHP 8-15 XD	
Trọng lượng theo Qui trình EPTA-Procedure 01:2014 (chuẩn EPTA 01:2014)	kg	40,6
Cấp độ bảo vệ	⊕ / I	
Mã seri sản xuất	Xem mã seri sản xuất (biển thông số) trên máy phun rửa cao áp.	

Các giá trị đã cho có hiệu lực cho điện thế danh định [U] 230 V. Đối với điện thế thấp hơn và các loại máy dành riêng cho một số quốc gia, các giá trị này có thể thay đổi.

Chu trình khởi động làm giảm điện áp xảy ra thoáng nhanh. Sự gây nhiễu động đối với các thiết bị/máy móc khác có thể xảy ra trong trường hợp ở vào tình trạng không thuận lợi của hệ thống điện nguồn. Không có sự cố xảy ra đối với hệ thống có trở kháng dưới 0,153 ohm.

Lắp và Vận Hành

Loại công việc	Hình ảnh	Trang
Các món được giao	1	59
Lắp Ráp Tay Nắm	2	60
Lắp vòi hút	3	61
Lắp que đo để làm thông hơi	4	62
Rót đầy bình chứa chất tẩy rửa	5	62
Nối nước vào	6	63
Làm sạch bộ lọc nước	7	63
Nối vòi nguồn nước cung cấp áp suất cao/miệng vòi	8	64
Điều chỉnh áp suất nước	9	64
Điều chỉnh tia nước	10	65
Mở và Tắt	11	65
Làm sạch miệng vòi	12	65

Bắt đầu

Cho Sự An Toàn của Bạn



Cảnh báo! Tắt máy, tháo phích cắm ra khỏi nguồn điện trước khi điều chỉnh, làm vệ sinh hoặc do cáp bị đứt, hư hỏng hay rối.

Máy của bạn đã được cách điện hai lớp để giữ an toàn và không cần dây nối đất. Điện thế vận hành máy là 230 V AC, 50 Hz (các nước ngoài khối EU có thể sử dụng điện thế 220 V, 240 V).

Sử dụng thiết bị ngắt mạch tự động (RCD) với cường độ dòng điện ngắt mạch không lớn hơn 30 mA để nâng cao sự an toàn về điện. Luôn luôn kiểm tra RCD của bạn trước mỗi lần sử dụng.

Cấp điện kèm theo máy phải được kiểm tra các dấu hiệu hư hỏng theo định kỳ và chỉ nên sử dụng nếu ở tình trạng hoàn hảo.

Nếu như cần phải thay dây dẫn điện thì công việc này phải do hãng Bosch, hay một đại lý được Bosch ủy nhiệm thực hiện để tránh gặp sự nguy hiểm do mất an toàn.

Chỉ sử dụng loại cáp nối dài thích hợp.



CẢNH BÁO! Cáp nối dài không phù hợp có thể nguy hiểm. Cáp nối dài, phích cắm, phích và ổ cắm phải có cấu tạo chống nước và có mục đích sử dụng ngoài trời.

Chỉ nên sử dụng dây, cáp, dây chì, trục quần dây nếu những thiết bị này đáp ứng chuẩn EN 61242/IEC 61242 hay IEC 60884-2-7.

Nếu bạn muốn sử dụng cáp nối dài khi vận hành thiết bị của bạn, chỉ sử dụng dây cáp có kích thước như sau:

- Diện Tích Dẫn Điện Danh Định từ 1,5 mm đến 2 cho cáp dài tối đa 20 m đối với Bộ Dây Nối Dài

Các bộ nối (phích cắm và ổ cắm) phải được giữ khô ráo và để cách mặt đất.

Khuyến nghị ta đặt bộ nối dựa theo cách trục quần dây được thiết kế, có ổ cắm cách mặt đất ít nhất là 60 mm.

Ghi chú: Nếu sử dụng cáp nối dài, cáp phải có dây tiếp đất và nối thông qua phích cắm vào cáp tiếp đất của hệ thống cung cấp điện của bạn, phù hợp với các qui định an toàn đã được chỉ định rõ.

Dựa theo sách hướng dẫn của nhà sản xuất dây nối dài, dây chì, trục quần và các qui định của địa phương của bạn về dây dẫn điện.

Nếu chưa hiểu rõ, hãy liên hệ một thợ điện chuyên nghiệp hay Trung Tâm Dịch Vụ Bosch gần nhất.

Đối với các sản phẩm **không bán ở GB:**

CẢNH BÁO: Vì sự an toàn của bạn, phích cắm vào thiết bị phải được nối vào dây nối dài. Đầu nối của dây nối dài phải chống được nước văng vào, đầu nối này phải được làm bằng cao su hay bọc cao su. Dây nối dài phải có vỏ chụp bảo vệ đầu dây.

Thu nước vào từ bể chứa mở

- Vận vòi hút có lắp bộ lọc (số mã sản phẩm của bộ hút đặc biệt F 016 800 335) vào phần nối nước.
- Cho thiết bị ứng dụng hoạt động ở chế độ áp suất thấp.
- Để cho thiết bị ứng dụng hoạt động khoảng 10 giây sau đó tắt đi. Lập lại qui trình này đôi ba lần cho đến khi nước thoát ra đồng đều và không có bọt bóng.

Để ngăn ngừa thiết bị bị hư hỏng, không cho máy hoạt động mà không có nước.

Vận Hành

Bắt đầu

Gắn vòi cung cấp nước (không giao kèm) vào nguồn cung cấp nước và vào máy.

Nối thiết bị ứng dụng vào nguồn điện chính và nhớ chỉnh đặt công tắc chính nằm ở vị trí tắt.

Mở vòi nước.

Nhấn khóa an toàn để nhả cò bấm. Bóp hoàn toàn cò bấm vào cho đến khi dòng nước chảy ra đều đặn để tổng không khí trong máy và vòi cung cấp nước ra. Nhả cò bấm.

Chúc mũi cần bóp hướng xuống. Nhấn khóa an toàn của cò bấm để nhả cò bấm. Bóp hoàn toàn cò bấm vào.

Bật công tắc tắt/mở.

Chức năng ngừng tự động

Máy được thiết kế để tắt mô-tơ khi cò bấm trên cần bóp được nhả ra.

Hướng Dẫn Sử Dụng

Tổng quát

Bảo đảm máy phun rửa cao áp nằm trên mặt phẳng.

Không được cố với tới bằng vòi áp suất cao hay di chuyển máy phun rửa cao áp bằng cách kéo vòi ống, điều này có thể làm cho máy bị mất thăng bằng và lật xuống.

Không được làm xoắn hay thắt nút hoặc để xe có động cơ cán qua vòi áp suất cao. Không được để trần vòi áp suất cao vào cạnh hay góc bén.

Không bao giờ được sử dụng miệng vòi quay để rửa xe có động cơ.

Không được chèn nén hay điều chỉnh van an toàn đã được thiết lập.

Que đo

Máy phun rửa cao áp được giao cùng với một nắp vận để bảo quản sản phẩm, và một nắp vận thông hơi với que đo để sử dụng khi vận hành thiết bị.

Lời khuyên cho việc làm sạch bằng chất tẩy rửa

► **Chỉ sử dụng chất dùng làm sạch đặc biệt thích hợp cho máy phun rửa cao áp.**

Chúng tôi khuyến nghị bạn nên sử dụng chất tẩy rửa một cách vừa phải vì môi trường. Tuân theo khuyến cáo pha loãng trên nhãn chất tẩy rửa.

56 | Tiếng Việt

Qua đề nghị các loại chất tẩy rửa và bảo dưỡng đặc thù, Bosch bảo đảm sự hoạt động của thiết bị không bị trục trặc.

Giới thiệu phương pháp làm sạch**Bước 1: làm rõ chất bẩn**

Phun chất tẩy rửa lên một cách vừa phải và để tạo phản ứng trong một thời gian ngắn.

Bước 2: Tổng bỏ chất bẩn

Phun tẩy chất bẩn đã rửa bằng tia phun cao áp.

Ghi Chú: Khi phun tổng chất bẩn/chất tẩy rửa để làm sạch bề mặt đứng, phun từ chân đáy và hướng lần lên trên. Rửa từ phía trên và đi lần xuống dưới.

Xử lý Hỏng hóc

Có vấn đề	Nguyên Nhân Có Thể Gây Ra	Biện Pháp Sửa Chữa
Mô-tơ không khởi hoạt	Chưa cắm phích	Cắm phích vào
	Ổ cắm của nguồn điện chính bị hỏng	Sử dụng ổ cắm khác
	Cầu chì hư/nổ	Thay cầu chì
	Cáp nối dài bị hư hỏng	Thử không sử dụng cáp nối dài
	Bộ bảo vệ mô-tơ được kích hoạt	Để cho nguội xuống 15 phút
Mô-tơ ngừng	Đóng băng	Đợi cho bơm/vòi cung cấp nước/phụ kiện tan băng
	Cầu chì hư/nổ	Thay cầu chì
	Điện thế nguồn không đúng	Kiểm tra điện thế nguồn có phù hợp với đặc tính kỹ thuật trên biển loại máy
Cầu chì nổ	Bộ bảo vệ mô-tơ được kích hoạt	Để cho nguội xuống 15 phút
	Cầu chì không đúng cường độ dòng điện định mức	Đổi sang nguồn điện cao hơn mức amp tiêu thụ của máy phun rửa cao áp
Mô-tơ hoạt động nhưng không có áp suất	Miệng vòi bị nghẽn một phần	Làm sạch miệng vòi
Mô-tơ “phát ra tiếng” nhưng không khởi động	Nguồn điện cung cấp không đủ	Kiểm tra điện thế của nguồn điện cung cấp có phù hợp với điện thế trên biển thông số
	Điện thế giảm do sử dụng cáp nối dài	Kiểm tra đặc tính kỹ thuật của cáp nối dài
	Thiết bị ứng dụng từ lâu không được sử dụng	Liên hệ Trung Tâm Dịch Vụ Bosch
	Trục trặc với thiết bị TSS (Hệ Thống Ngừng Toàn Bộ)	Liên hệ Trung Tâm Dịch Vụ Bosch

Có vấn đề	Nguyên Nhân Có Thể Gây Ra	Biện Pháp Sửa Chữa
Áp suất dao động	Có hơi trong vòi cung cấp nước vào/bơm	Để cho máy phun rửa cao áp hoạt động mà cần bóp và miệng vòi để mở ở áp suất thấp cho đến khi có lại áp suất làm việc thông thường
	Nước cung cấp không đủ	Kiểm tra nguồn cung cấp nước có phù hợp với các đặc điểm kỹ thuật. Đặc điểm kỹ thuật tối thiểu của đường kính vòi cung cấp nước là 1/2" hay 13 mm
	Bộ lọc nước bị nghẽn	Làm sạch bộ lọc nước
	Vòi cung cấp nước bị bóp nghẹt	Duỗi thẳng vòi cung cấp nước bị xoắn hay thắt nút
	Vòi áp suất cao quá dài	Tháo vòi áp suất cao nối dài ra. Thử lại (chiều dài vòi nối dài tối đa 7 m)
Áp suất quá thấp, nhưng ổn định	Miệng vòi mòn	Thay miệng vòi
Ghi chú: Một số loại phụ kiện thông thường tạo ra áp suất thấp	Van khởi động/ngừng mòn	Kích hoạt nhanh cò (cần bóp) năm lần liên tiếp
Mô-tơ khởi động nhưng có áp suất hạn chế hay không có áp suất làm việc	Không có nước cung cấp	Nối nước cung cấp vào
	Bộ lọc nước bị nghẽn	Làm sạch bộ lọc nước
Máy phun rửa cao áp tự khởi động không bình thường	Miệng vòi bị nghẽn	Làm sạch miệng vòi
	Bơm/cần bóp bị rò rỉ	Liên hệ Trung Tâm Dịch Vụ Bosch
Nước rò rỉ từ máy	Bơm bị rò rỉ	Sự rò rỉ nước chút ít có thể chấp nhận được; trong trường hợp rò rỉ quá nhiều, liên hệ Trung tâm Dịch vụ
	Miệng vòi điều chỉnh được ở chế độ áp suất cao	Chỉnh đặt miệng vòi "Lo" chỉnh đặt
	Chất tẩy rửa quá đậm đặc	Pha loãng với nước
	Vòi áp suất cao nối dài đang được sử dụng	Lắp vòi nguyên bản
	Sự đọng lại hay nghẽn vòng chày của chất tẩy rửa	Xối nước sạch và loại bỏ bất cứ cản trở nào. Nếu sự trục trặc vẫn còn, liên hệ Trung Tâm Dịch Vụ Bosch.

Bảo Dưỡng và Bảo Quản

Bảo Dưỡng

- ▶ **Tắt máy, rút phích ra khỏi nguồn cung cấp điện và tháo nguồn cung cấp nước.**

Ghi Chú: Để bảo đảm sự hoạt động lâu dài và đáng tin cậy, thực hiện thường xuyên việc bảo trì sau đây.

Thường xuyên kiểm tra các khuyết điểm để nhận thấy như những điểm lắp nối không chặt, bị mòn hay các bộ phận bị hư hỏng.

Kiểm tra các nắp che và chắn không bị hư hỏng và được lắp đúng cách. Thực hiện việc bảo trì cần thiết hay sửa chữa trước khi sử dụng.

Vận Chuyển

Để di chuyển máy phun rửa cao áp, sử dụng tay nắm trên và di chuyển máy phun rửa cao áp bằng các bánh lăn.

Để mang máy phun rửa cao áp lên hay xuống bậc thang hay vượt qua các vật chướng ngại, phải dùng tay nắm trên để nhắc bóng máy.

58 | Tiếng Việt**Sau khi sử dụng/Bảo quản**

Lau sạch toàn bộ mặt ngoài của máy bằng vải hay cọ mềm. Không được sử dụng nước, dung môi hay chất đánh bóng. Tẩy sạch cặn bám, đặc biệt là ở các khe thông gió.

Cuối mùa bảo quản: Tháo nước ra khỏi bơm và cho mô-tơ hoạt động trong vài giây. Kéo cò để tháo toàn bộ nước ra.

Không được đặt các vật dụng khác lên trên máy.

Bảo đảm cáp không bị rối khi bảo quản. Không được làm xoắn, thắt nút với áp suất cao.

Dịch Vụ Sau Khi Bán và Dịch Vụ Ứng Dụng

www.bosch-do-it.com

Trong mọi thư từ giao dịch và đơn đặt hàng phụ tùng thay thế, xin vui lòng luôn luôn viết đủ 10 con số mã hàng hóa ghi trên nhãn loại máy của máy.

Việt Nam

CN Cty TNHH Bosch Vietnam tại TP. Hồ Chí Minh
Tầng 10, Tòa nhà 194 Golden
473 Điện Biên Phủ
Phường 25, Quận Bình Thạnh
Tp. Hồ Chí Minh
Tel.: (08) 6258 3690
Fax: (08) 6258 3692
Hotline: (08) 6250 8555
www.bosch-pt.com.vn

Campuchia

Công ty TNHH Robert Bosch (Campuchia)
Đơn nguyên 8BC, GT Tower, Tầng 08,
Đường 169, Tiệp Khắc Blvd, Sangkat Veal Vong,
Khan 7 Makara, Phnom Penh
VAT TIN : 100 169 511
Tel.: +855 23 900 685
Tel.: +855 23 900 660
www.bosch.com.kh

Bảo Vệ Môi Trường

Các hóa chất nguy hiểm cho môi trường không được để cho chảy thấm vào đất, nước ngầm hay ao hồ, sông suối v.v..

Đối với việc sử dụng các chất làm sạch, tuân theo các hướng dẫn trên bao bì và nồng độ chính xác được định rõ.

Đối với việc rửa xe có động cơ, phải tuân theo các qui định của địa phương: Không để cho dầu được phun ra thấm vào nguồn nước ngầm. Tái chế các nguyên liệu thô thay vì thải bỏ.

Thải bỏ

Máy phun rửa cao áp, phụ kiện, và bao bì phải được phân loại để tái chế theo hướng thân thiện với môi trường.



Không được thải bỏ máy phun rửa cao áp vào rác sinh hoạt gia đình!

Chỉ dành cho các nước EC:

Căn cứ theo những qui tắc hướng dẫn thực hiện 2012/19/EU của khối EC đối với các Thiết Bị Điện và Điện Tử được Thải Bỏ và sự thực thi thành luật quốc gia, các thiết bị điện và điện tử không còn sử dụng được nữa phải thu hồi riêng biệt và thải bỏ theo cách ứng xử đúng với môi trường.

Được quyền thay đổi nội dung mà không phải thông báo trước.

1



41kg

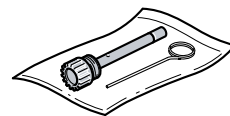
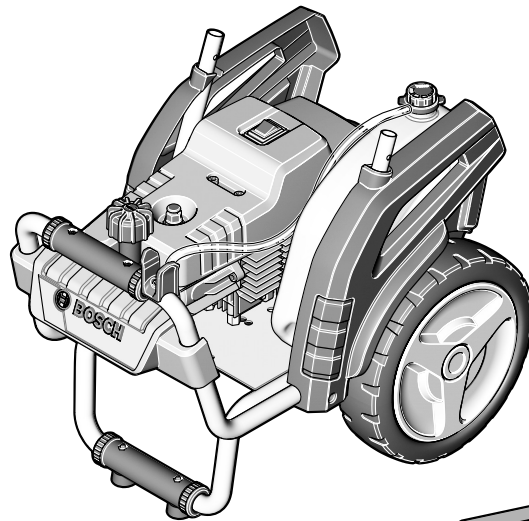
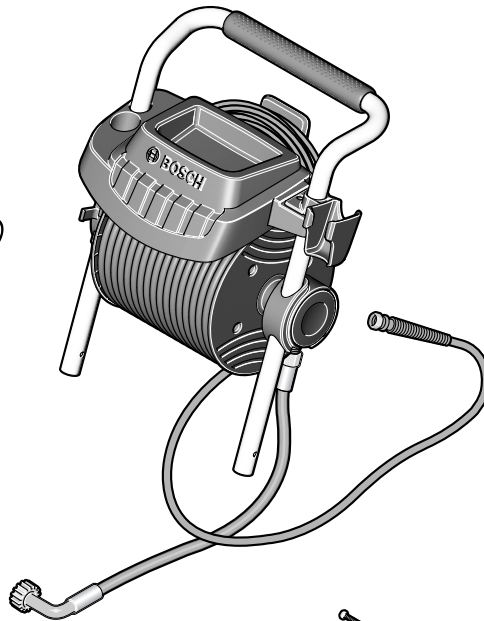
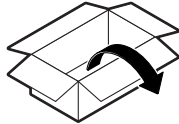



2

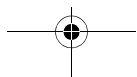
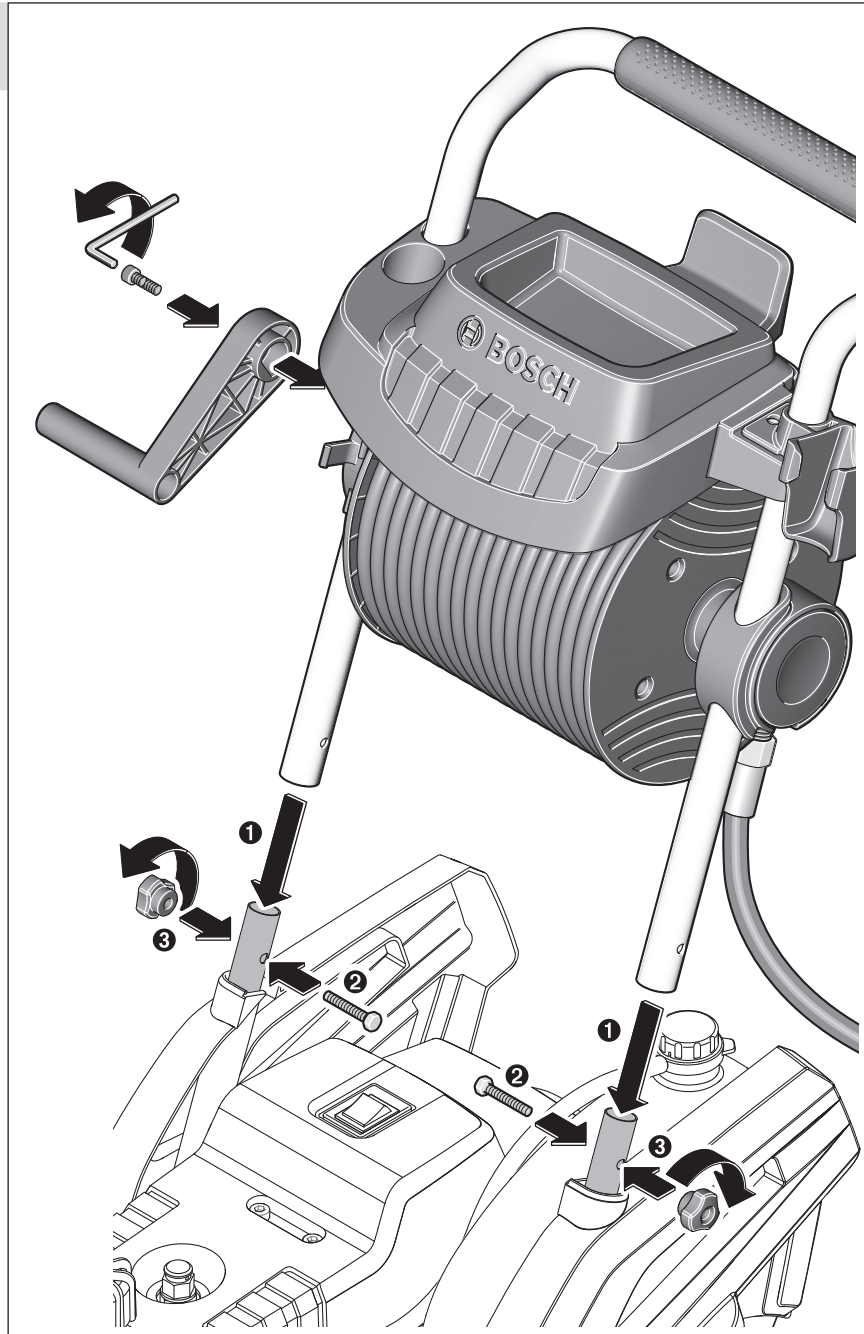



3

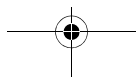
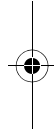
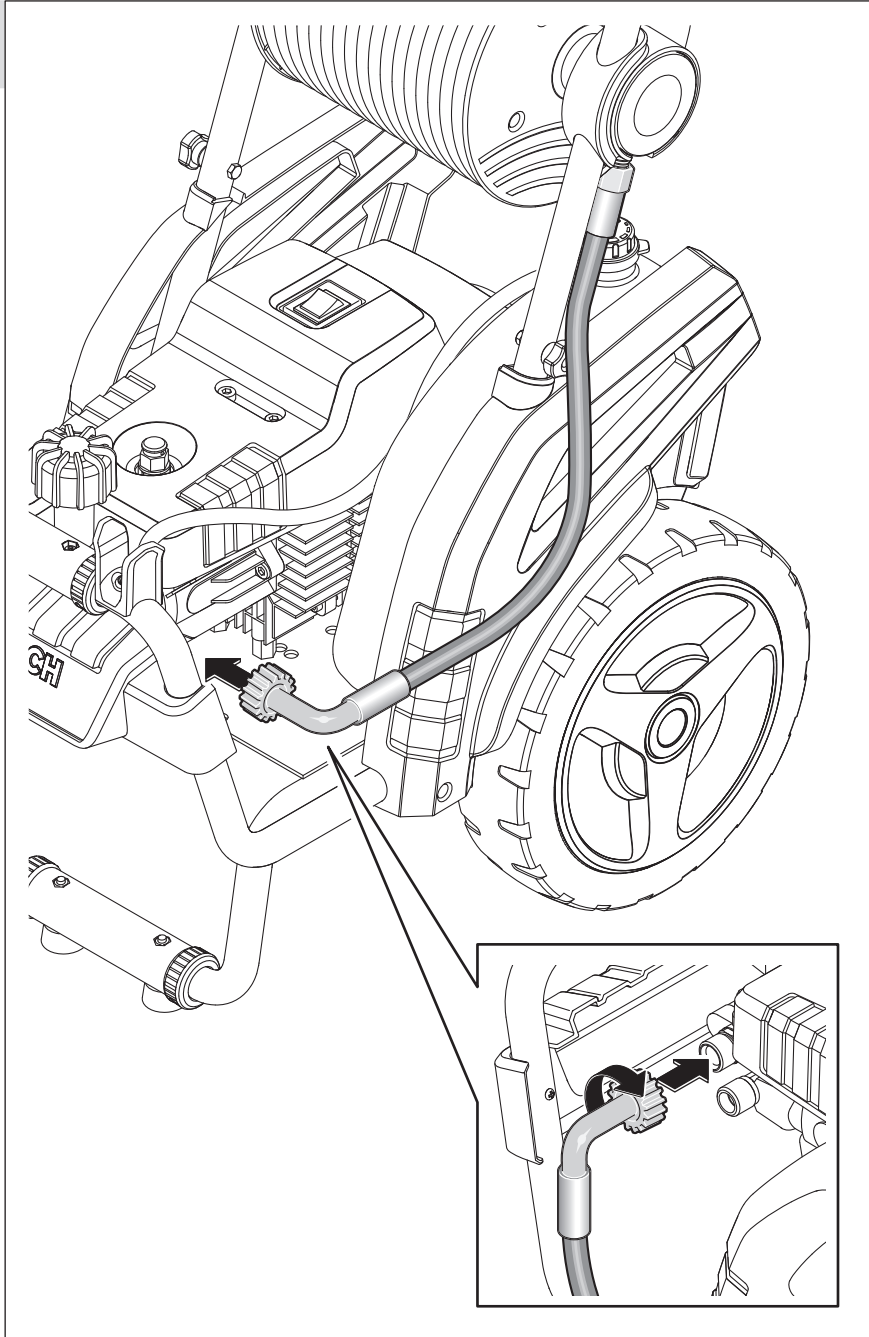



4

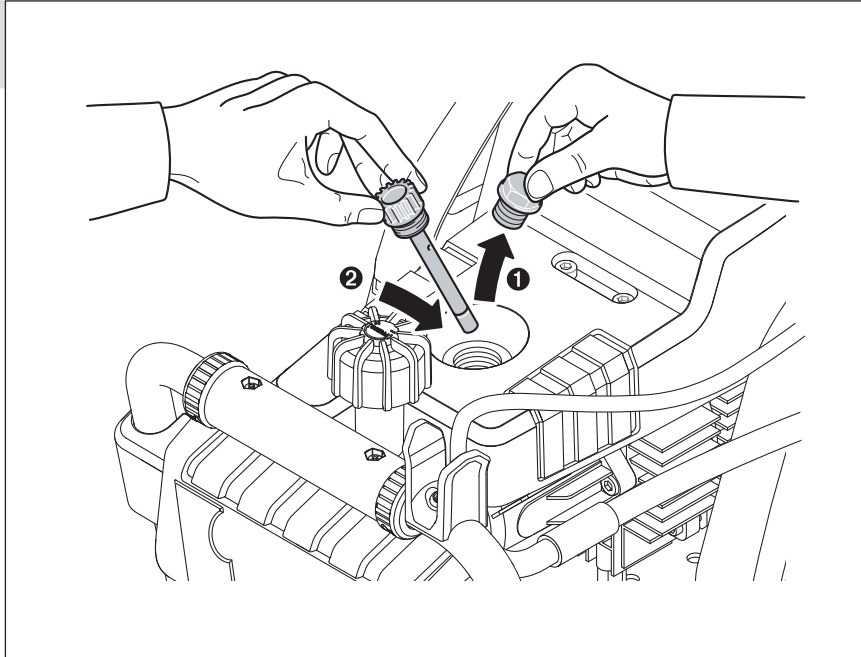

5

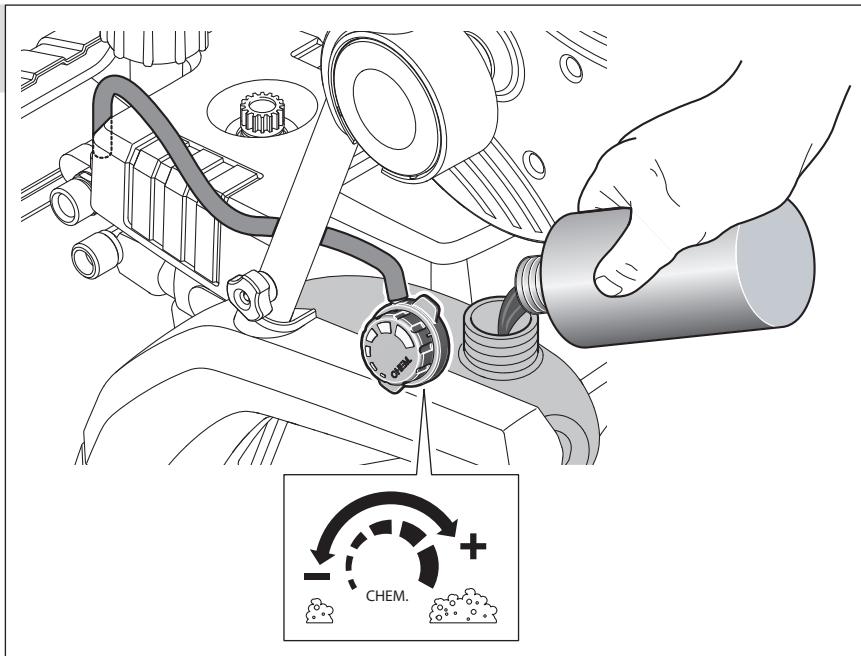



6

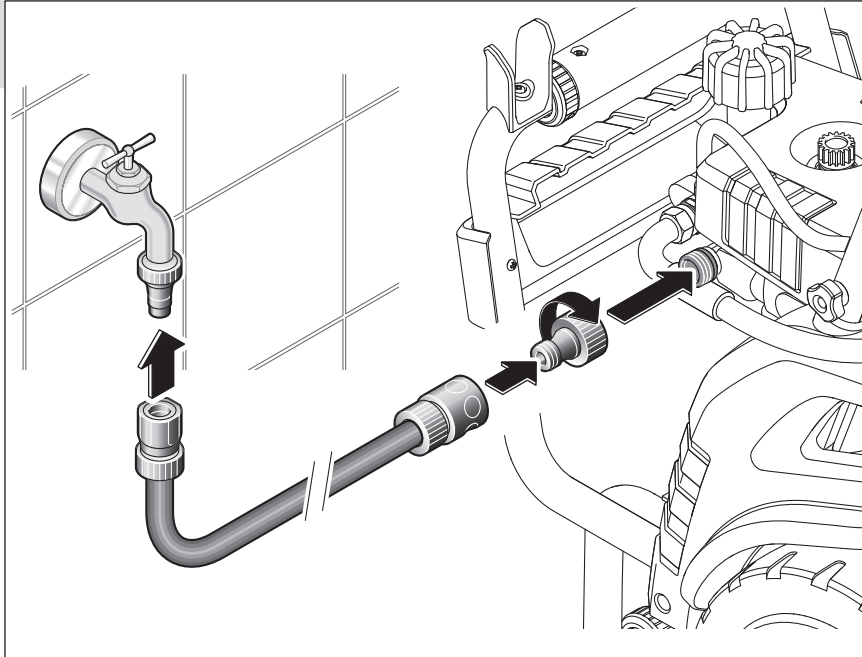

7

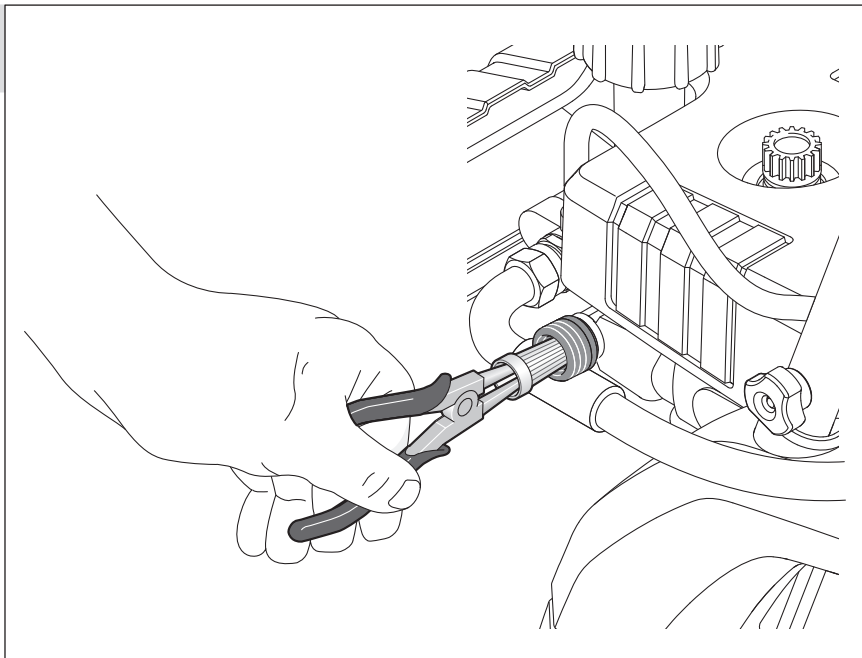

8

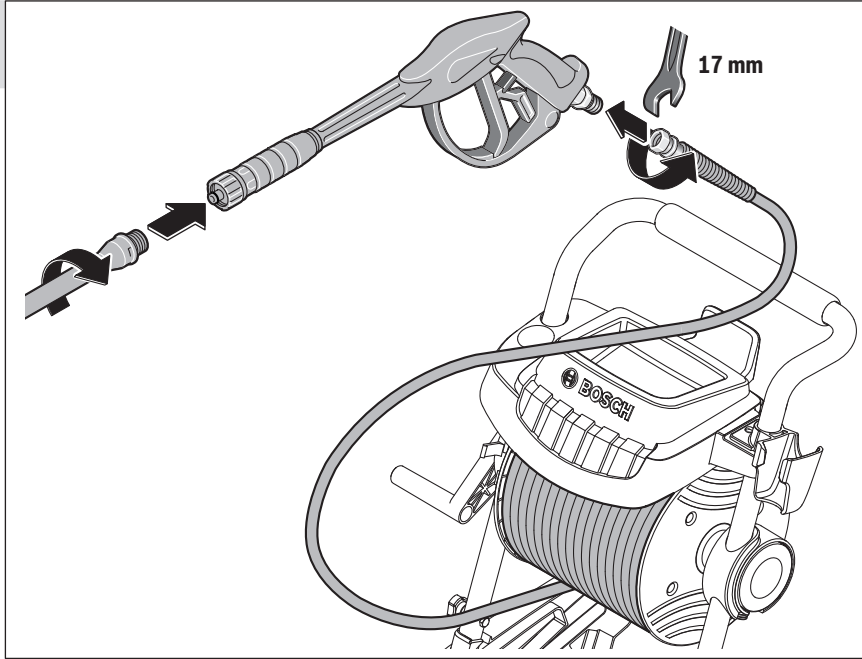

9

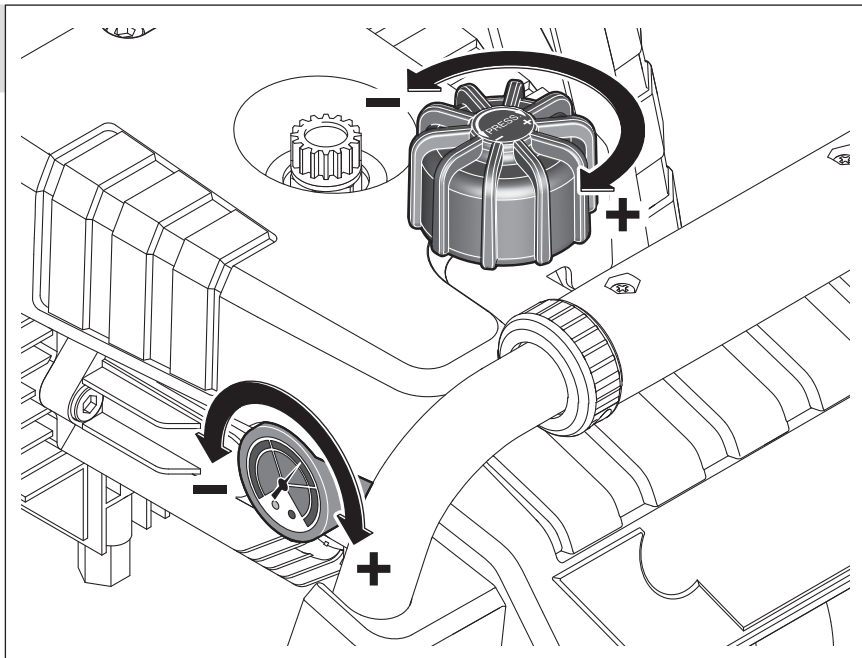



10

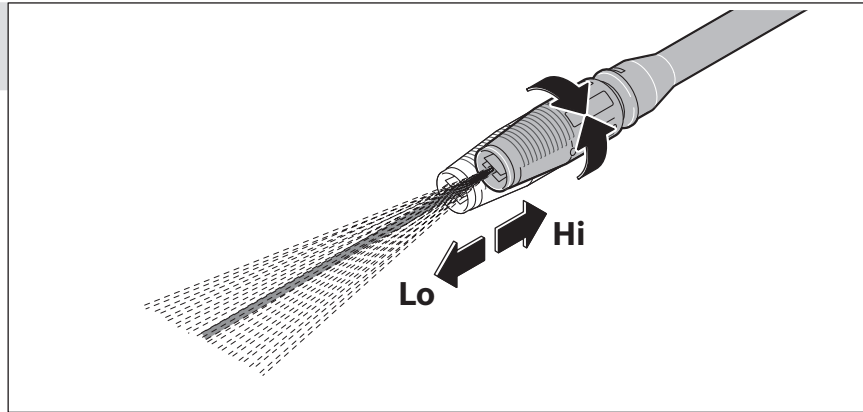

11

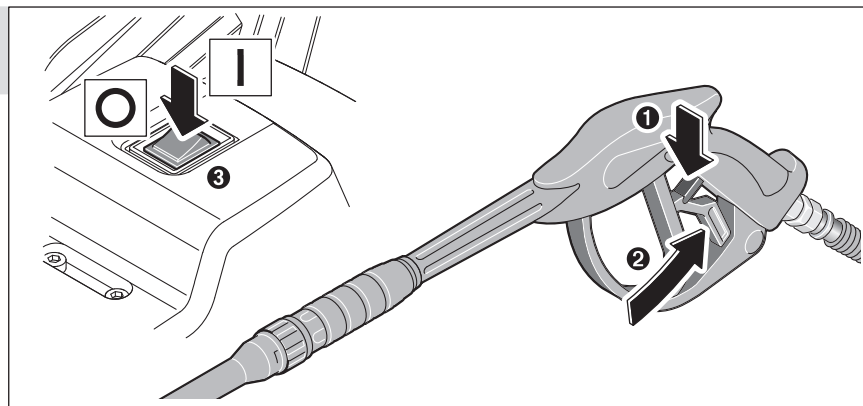

12

